

NET-VISION

Version 8.x



Socomec Resource Center
To download, brochures, catalogues
and technical manuals

CONTENTS

1. ELECTRONIC EMISSION NOTICE	5
1.1. FEDERAL COMMUNICATIONS COMMISSION (FCC)	5
2. SAFETY INFORMATION	5
2.1. FOR NET VISION CARD	5
2.2. FOR NET VISION BOX	5
3. GENERAL DESCRIPTION	6
3.1. NET VISION PRESENTATION	6
3.2. SOCOMEC UPS COMPATIBILITY	6
3.3. NET VISION FEATURES	7
3.4. CYBERSECURITY	8
3.5. CERTIFICATE FOR HTTPS CONNECTION	9
4. REQUIREMENTS	10
4.1. WEB BROWSER	10
4.2. NET VISION EXPLORER	10
5. NET VISION INSTALLATION	10
6. UPS SERIAL LINK SETTINGS	10
7. NET VISION BOOT SEQUENCE	11
7.1. EMD LIGHTS SEQUENCE	11
7.2. MODBUS POLLING	11
7.3. UPS DATA BASE	12
7.4. UPS ARCHITECTURE:	12
8. NET VISION EXPLORER PRESENTATION	13
8.1. IP SETTINGS (ONLY FOR NV 7 AND 8)	13
8.2. BROWSE	13
8.3. FW UPGRADE	14
8.4. NET VISION SETTINGS FILE DOWNLOAD	14
8.5. BATCH OPERATION	14
8.6. SUPGRADE.EXE TOOL	14
9. IP ADDRESS CONFIGURATION	15
9.1. PREPARING NET VISION	15
9.2. DEFAULT IP ADDRESS	15
9.3. NET VISION ACCESS	15
9.4. IP SETTINGS USING NETWORK IF DHCP NOT PRESENT	15
9.5. IP SETTINGS USING A TERMINAL AND USB FOR NET VISION	15
10. RESET NET VISION WITH FACTORY SETTINGS	16
11. NET VISION USER INTERFACE	17
11.1. NET VISION HOME PAGE	17
11.2. NET VISION MENU	18
11.3. UPS ARCHITECTURE TREE-VIEW	21
11.4. UPS SYNOPTIC	21
11.5. USER LOGIN	22
12. UPS MONITORING	23
12.1. UNIT SYNOPTIC	23
12.2. SYSTEM SYNOPTIC	28
12.3. ALARM TABLE	29

13. UPS DASHBOARD	30
14. REAL TIME GRAPH	31
15. CLIENT TABLE	31
16. UPS MANAGEMENT	32
16.1. UPS CONTROL	32
16.2. BATTERY TEST	33
16.3. BATTERY TEST SCHEDULE	33
16.4. ECO MODE SCHEDULE	33
16.5. WEEKLY SHUTDOWN SCHEDULE	34
16.6. SPECIAL DAY SHUTDOWN SCHEDULE	34
16.7. POWER SHARE	35
16.8. SHUTDOWN MANAGEMENT	36
17. EMD DEVICE MANAGEMENT	39
18. NET VISION MANAGEMENT	40
18.1. DATE AND TIME	40
18.2. NET VISION CONFIGURATION	41
18.3. NET VISION CONTROL	42
18.4. MULTI-USER TABLE	43
18.5. REMOTE VIEW PRO CONFIGURATION	43
18.6. REMOTE VIEW PRO SERVER CONFIGURATION	44
18.7. SNMP V3 USM TABLE CONFIGURATION	45
18.8. SNMP TRAP RECEIVERS CONFIGURATION	45
18.9. EMAIL NOTIFICATION	47
18.10. AUTHENTICATION CONFIGURATION	48
18.11. WOL TARGETS	49
18.12. MODBUS TCP CONFIGURATION	49
18.13. SYSLOG SETUP	50
18.14. DDNS SETUP	50
18.15. FIREWALL SETUP	51
18.16. UPNP PROTOCOL	51
18.17. MULTI-LANGUAGE	51
18.18. FIRMWARE UPGARDE	51
19. NET VISION IOT GATEWAY	52
19.1. REQUIREMENTS	52
19.2. IOT GATEWAY ACCOUNT CREATION	52
19.3. NTP SETTINGS	52
19.4. PROXY SETTING	53
19.5. SYNCHRONIZATION	53
19.6. IOT SERVICE ACTIVATION	54
20. EXTERNAL LINK SETUP	56
21. HISTORY LOG	57
21.1. HISTORY LOG	57
21.2. UPS EXTENDED HISTORY LOG	59
21.3. UPS EVENTS LOG	61
21.4. NET VISION EVENTS LOG	62
21.5. CLEAR & SAVE LOG DATA	64
22. APPENDIX	65

CERTIFICATE AND CONDITIONS OF WARRANTY

Installing the software means full acceptance of all contractual terms. For this reason, please read all the points listed below carefully. If you do not agree with one or more of the contractual terms, do not install this software and/or return it immediately to SOCOMEC.

1. COPYRIGHT AND INTELLECTUAL PROPERTY OWNERSHIP RIGHTS

The user of the software acknowledges that all rights referred thereto and the copyright belong to SOCOMEC, in relation to both the source code and the object code.

Anyone entering into possession of the software without prior authorization from SOCOMEC must immediately uninstall it, if it has been installed and return it to SOCOMEC. If such persons fail to take this action SOCOMEC will exercise its rights to the full extent permitted by civil and criminal law.

The software and documentation are protected by copyright. The unlawful use and/or copying partially or totally of the software shall lead to claims for damages. This documentation and software are not specifications. SOCOMEC reserves the right to make any changes to data without prior notice.

SOCOMECE retains the full and exclusive ownership of all intellectual rights, such as, but not limited to the ones related to documentation, software, source code, object code, etc. Only a personal right to utilize the documentation and software for the application indicated by SOCOMEC is granted to their recipients. All reproduction, modification, dissemination of this documentation and software whether in part or whole and by any manner are expressly prohibited except upon SOCOMEC's express prior written consent.

2. LICENSE TO USE

The NET VISION, NET VISION Explorer and supporting documentation are freely installable for private use solely.

The software contains confidential information. This license does not authorize the user to modify, adapt, decompile or disassemble the software in question or to reconstruct the source code using any other method. SOCOMEC will protect its rights against any such unauthorized use to the full extent permitted by civil and criminal law.

The software may not be hired out to third parties. The license of use of this software is issued exclusively for the purposes laid down in the software documentation.

3. ENTRY INTO FORCE AND DURATION OF THE LICENSE

This license enters into force on the day of installation of the software, whereby the user accepts these conditions of use and liability. The license is open term and has no date of expiry. The licence and the limited rights of use by the user of the software will be invalidated in case of a breach of any of the points laid down in paragraphs "1. Copyright and Intellectual Property ownership rights" and "2. License".

4. WARRANTY CONDITIONS

SOCOMECE neither implicitly nor explicitly provides any warranty concerning the usability of the software. Despite the extensive use of resources to develop the software, no guarantees are provided concerning the absence of errors. SOCOMEC may provide the support needed to solve any errors present in the software. Such support is limited to the correction of programming errors and is not extended to the implementation of new functions that are not present in the version of the software used by the user. Should the user find any manifest or hidden errors, they must be notified to SOCOMEC in writing.

5. SOFTWARE UPDATES

This licence does not grant the right to receive software updates, or new versions.

6. LIMITATIONS OF LIABILITY

SOCOMECE shall not be held liable, under any circumstances, for damage of any kind, including economic losses, directly or indirectly consequential to the use of, or inability to use the software.

7. SEVERABILITY

If any clause of this contract is found to be ineffective or become ineffective for any reason whatsoever, the remaining terms of the licence shall still apply. The unenforceable clause or ineffective provisions will be replaced by a clause, also with retroactive effect, that addresses subsequently identified requirements, within the scope of legal enforceability.

8. AMENDMENTS TO THE LICENCE

Any amendment to this licence must be made in writing.

9. APPLICABLE LAW

This contract is subject to French law.

The information contained herein, the software and documentation, are the exclusive property of SOCOMEC.

1. ELECTRONIC EMISSION NOTICE

1.1. FEDERAL COMMUNICATIONS COMMISSION (FCC)

This equipment has been tested and found to comply with the limits for a Class B digital device, pursuant to Part 15 of the FCC Rules. These limits are designed to provide reasonable protection against harmful interference when the equipment is operated in a commercial environment.

1.1.1. CE NOTICE

This device complies with the EMC directive of the European Community and meets or exceeds the following technical standard:

- EN 55032:2015/A1:2020, Class B – “Limits and Methods of Measurement of Radio Interference Characteristics of Information Technology Equipment.” This device complies with the CISPR Class B standard
- EN IEC 61000-3-2:2019/A1:2021 – “Electromagnetic compatibility”

2. SAFETY INFORMATION

2.1. FOR NET VISION CARD

- All servicing of this equipment must be performed by qualified service personnel. Remove rings, watches, and other jewellery before servicing the unit.
- Before plugging in/pulling out the NET VISION card to/from the UPS, please make sure that the power supplying the UPS has been switched off or on maintenance bypass for MASTERYS, MODULYS and DELPHYS UPS. Hot swap of the NET VISION in UPS is inhibited.

2.2. FOR NET VISION BOX

- To reduce the risk of fire or electric shock, install the unit in a temperature-controlled indoor area free of conductive objects. Do not place the unit near liquids or in an excessively humid environment.
- Do not allow liquids or foreign objects to enter the unit
- The unit does not contain any user-serviceable parts. Do not open the unit.
- All servicing of this equipment must be performed by qualified service personnel. Remove rings, watches, and other jewellery before servicing the unit.
- Before maintenance, repair or shipment, the unit must be switched off completely and unplugged and all connections removed.
- Before plugging in the NET VISION power adaptor, please make sure the power source rating matches the NET VISION power adaptor rating.

3. GENERAL DESCRIPTION

3.1. NET VISION PRESENTATION

NET VISION is a network adapter for the professional monitoring and remote control of a single and modular UPS or parallel UPS system.

The NET VISION network adaptor allows a UPS to connect directly the Ethernet network allowing secure management of the UPS over the network using a web browser or NMS application via SNMP. The protocols used for connection are independent of the platform and operating system, therefore NET VISION is extremely flexible and suitable for all systems.

In addition to monitoring and control, the NET VISION interface provides a high level of protection for standalone servers or hosts managing virtual machines powered by the UPS.

In critical conditions, up to 250 devices powered by the UPS can be switched off in an orderly sequence whilst ensuring data integrity.

The remote shutdown is provided by a client shutdown to be installed on all standalone servers (JNC) or on a virtual machine (VIRTUAL-JNC) that require this automatic function.

JNC and VIRTUAL-JNC are shutdown agent software available for free on SOCOMEC's web site.

3.2. SOCOMEC UPS COMPATIBILITY

NET VISION is compatible with the following SOCOMEC UPS products:

- NETYS PR
- NETYS RT
- ITYS All ranges
- ITYS-PRO
- MODULYS All ranges
- MASTERYS All ranges
- DELPHYS MP - MX
- DELPHYS BC - GP - Xtend - XL

3.3. NET VISION FEATURES

3.3.1. UPS FUNCTIONS

- Real-time UPS health monitoring
- Comprehensive UPS management and flexible configuration via Web Browser
- Automatic detection of UPS architecture: single, modular, or parallel system
- Battery test management (if supported by UPS)
- UPS controls (If enabled by UPS)
- UPS date and time synchronisation (if enabled by UPS)
- Automatic UPS events notification via E-mail and SNMP Trap
- Complete shutdown procedure to protect up to 250 servers/workstations or HOSTS/VM from data loss due to power outage
- Scheduling shutdown/start-up/reboot of UPS via remote control (only for single phase UPS)
- Regularly records UPS parameters for statistical analysis and event diagnostics

3.3.2. NETWORK SERVICES

- Assigned IP automatically via DHCP or BOOTP
- Standard RFC1628 UPS MIB and NET VISION proprietary MIB supported
- 10/100Mbps and 1Gbps fast Ethernet auto-sense network environment
- Configuration utility simplifies the firmware upgrade process
- Radius users account support
- IPv4 and IPv6 dual-stack
- Supports MODBUS TCP protocol to connect monitoring equipment
- Digital output to support relay control device (EMD)
- Firewall network access control avoiding non-authorized IP access

3.3.3. NETWORK PROTOCOLS

- IPv4 / v6
- TLS 1.3
- HTTP / HTTPS with certificate
- DHCP / BOOTP
- SNMP v1 / v2c / v3 (MD5-SHA / DES-AES)
- SMTP over TLS
- SSH v2
- UPnP
- NTP / NTS
- WOL
- RADIUS
- TFTP
- SYSLOG over TLS

3.4. CYBERSECURITY

NET VISION, as any devices connected to an Ethernet network, must be protected against any risk of cyber-attack or data loss/destruction. This protection is the responsibility of the user of the NET VISION device.

Therefore, the recommendations below must be in line with the IT system security policy implemented on site, where the NET VISION device is connected.

AWARENESS OF THE SECURITY POLICY:

NET VISION users and administrators are aware of and trained in good IT security practice (information and compliance with corporate security policy, authentication procedure management and password safety, online session management, risks of fishing...)

NETWORK SECURITY:

The IT system architecture must be able to safeguard resources, by segmenting the network according to their degree of sensitivity and using a variety of protective devices (firewall, demilitarized zone, VLAN, network anti-virus etc.).

DEVICE SECURITY:

Device security depends on its network environment, but also user behavior. In terms of the environment, elementary protective measures (filtering authorized stations by MAC address, opening service ports, selecting authorized applications etc.) are highly recommended.

DATA SECURITY:

Data security covers several aspects, in particular the confidentiality, integrity, authenticity and availability of data. Special care is required with data security and archiving procedures on backup devices both inside and outside the company.

ACCESS AND AUTHENTICATION MANAGEMENT:

Managing access to resources and data is a crucial element of the IT system's security policy. Each user requires an account and access rights corresponding to their profile. Access to the IT system's resources is controlled by a user authentication process, based on a minimum of a high-security user-name and password. The password management procedure, specifying the systematic modification of default passwords and their validity period, is included in the IT system's security policy.

CERTIFICATION

An independent Company expert in Cybersecurity, recognized by the ANSSI, has been certified that NET VISION technical security level is compliant with the state of art of the OWASP security recommendation / ISO27002:2022 standard.

The official attestation document is available on demand.



Recommendations to enhance NV security:

- Enabled HTTPS protocol and disable HTTP
- In case of using HTTP port to change port 80 to local port 8080 for example
- Disable all protocols and ports not used (SSH, PING, SMTP, UPnP, WOL, MODBUS TCP...)
- Change regularly the admin password. This password is valid for 90 days by default.
- Add user credentials for read only access

3.5. CERTIFICATE FOR HTTPs CONNECTION

3.5.1. USING HTTPs WITH CERTIFICATE.

Net Vision allows uploading an external certificate.

File format:

- .pem extension
- 8Kb max size
- Including Private key and Certificate sections:
-----BEGIN PRIVATE KEY-----
QlmljhdLIUHVG...
-----END PRIVATE KEY-----
-----BEGIN CERTIFICATE-----
mzoeirOUBgytv...
-----END CERTIFICATE-----

Upload CA file:

- Select the .pem file
- Upload

The Net Vision configuration page shows the name of current certificate in used. It is possible to remove the certificate clicking on remove button.

Upload CA file	<input type="button" value="Choose File"/> No file chosen
	<input type="button" value="Upload"/> nvtest.pem <input type="button" value="Remove CA file"/>

After enabling HTTPs protocol the secure connection can be performed.

Forcing the connection in case of self-generated certificate without Certification Authorities (trusted or not).

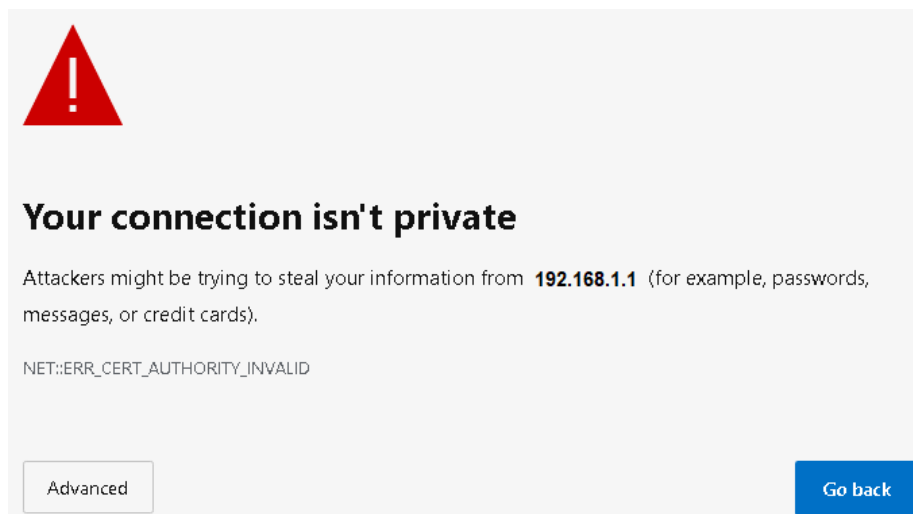

Select Advanced, and continue to site

Even in case of not secure warning, the HTTPs connection initiates with Net Vision using the uploaded certificate



The response time can be long during page downloading due to html page encryption algorithm.

3.5.2. USING HTTPs WITHOUT CERTIFICATE.

In that case the auto-generate certificate by Net Vision is used for the HTTPs connection. (Root CA – cacert.crt)

4. REQUIREMENTS

4.1. WEB BROWSER

NET VISION interacts with the end user through a web browser. All web browsers compliant with HTML, js and XML technologies can access to NET VISION pages.

4.2. NET VISION EXPLORER

This tool must be installed in a Windows™ computer to configure IP settings, to upload the NET VISION configuration, or to upgrade the FW. Please refer to the Appendix.

NET VISION Explorer detects all UPS connected on the same local network through NET VISION. This tool helps to check the IP addresses of each NET VISION.

NET VISION Explorer is compliant with all NET VISION FW versions from V5 to V8.

5. NET VISION INSTALLATION

NET VISION Card

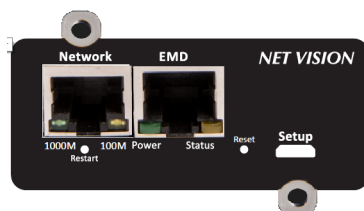

NET VISION Card is installed and screwed into one of the available COM-Slots. The metallic front part can be adapted, to fix the NET VISION to com-Slot depending on the UPS model.

NET VISION is powered by the UPS and communicates through serial link to the internal μ C board of the UPS.

The serial link COM port must be set on the UPS control panel to establish the communication with UPS.

 **WARNING:** Before installing the card, please note its MAC address: the 6 last char used as admin password the first time

 For box version and EMD installation, please refer to apendix

6. UPS SERIAL LINK SETTINGS

- NETYS / MODULYS range: 9600bds, no parity, slave 1
- ITYS: 2400bds, no parity, slave 1
- MODULYS XS - GP 2.0 - XL: 57600bds, no parity, slave 1: COM-Slot 1 or COM-Slot 2
- MASTERYS BC - GP - GP 2.0 - IP+ - EM: 9600bds, no parity, slave 1: COM-Slot 1 or COM-Slot 2
- MASTERYS BC+ - GP4: 57600bds, no parity, slave 1: COM-Slot 1 or COM-Slot 2
- DELPHYS MP - MP elite + - EM - MX: 9600bds, no parity, slave 1: COM-Slot 5 only
- DELPHYS BC - GP - GP 2.0 - Xtend: 9600bds, no parity, slave 1: COM-Slot 2 only
- DELPHYS BC - GP 2.0 - Xtend - XL
with Touch-Screen Display: 57600bds, no parity, slave 1: COM-Slot 1 or COM-Slot 2

7. NET VISION BOOT SEQUENCE

During NET VISION's starting phase, the Power EMD light is OFF and Status EMD light will flash till communication is established.

NET VISION automatically detects the protocol and UPS type. Once the communication is established, the Power EMD light is continuous; and the Status EMD light flashes when NET VISION is sending MODBUS request to the UPS. At the end of the boot sequence, the MODBUS polling starts and the NET VISION communicates with the UPS.

7.1. EMD LIGHTS SEQUENCE

POWER Green Power Light:

ON

OFF

STATUS Yellow Light:

ON

OFF

Baud rate detection

Synchro OK

Data base de-
tection

MODBUS polling

7.2. MODBUS POLLING

As NET VISION communicates with the UPS through the MODBUS serial link, the data refreshing depends on the baud rate and the number of units for parallel systems.

At 9600 bauds, the polling time for 1 unit is around 3 seconds. This polling time is to be multiplied by the number of units present in the system in order to have a global time of data refreshing.

7.3. UPS DATA BASE

NET VISION manages 2 types of UPS mapping:

- ‘JBUSP’ mapping for:
 - NETYS PR - RT
 - ITYS
 - MODULYS
 - MASTERYS MC - BC - GP - IP - EM
 - DELPHYS BC - GP - Xtend
- ‘VU-MAP’ mapping for:
 - ITYS-PRO
 - MODULYS XS - GP 2.0 - XM
 - MASTERYS BC+ - GP4
 - DELPHYS with touchscreen panel.

JBUSP TABLES

STATUS	S00 – S63	0x1020	4 w
ALARMS	A00 – A63	0x1040	4 w
MEASUREMENTS	M00 – M47	0x1060	48 w

VU-MAP TABLES

STATUS	S000 – S127	0x0030	8 w
ALARMS	A000 – A127	0x0038	8 w
MEASUREMENTS	M000 – M079	0x0040	80 w

MODBUS TCP access must follow the addresses according to the UPS mapping
Please refer to the Appendix: MODBUS TCP JBUSP and VU-MAP TABLE.

7.4. UPS ARCHITECTURE:

- Single Unit 1 phase and 3 phases
- Converter - without battery
- Module – without bypass
- Modular Unit up to 8 modules
- Parallel system, distributed bypass or centralized bypass, up to 6 Units (JBUSP) and 10 Units (VU-MAP)
- Modular system up to 4 Units – 24 modules.

8. NET VISION EXPLORER PRESENTATION

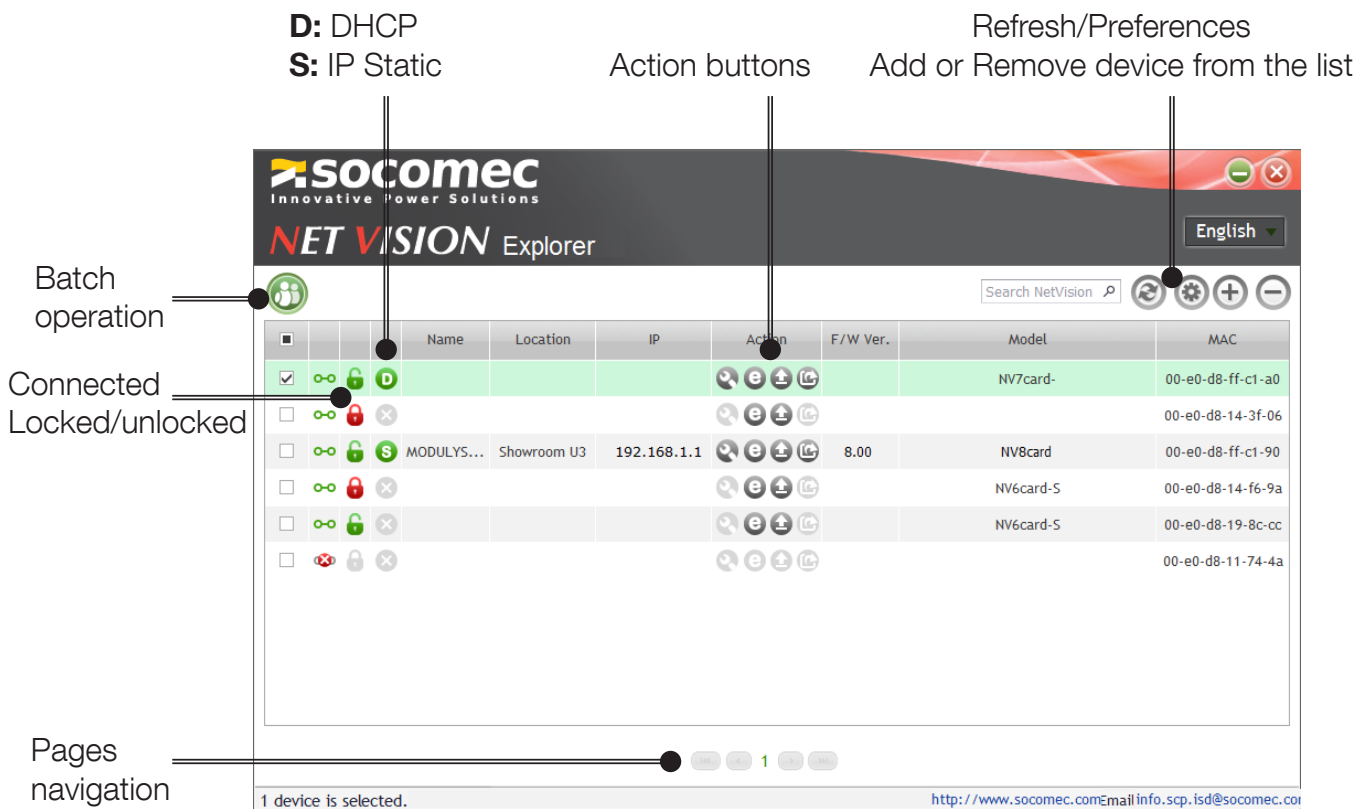

8.1. IP SETTINGS (ONLY FOR NV 7 AND 8)

Click on to open the IP settings window:

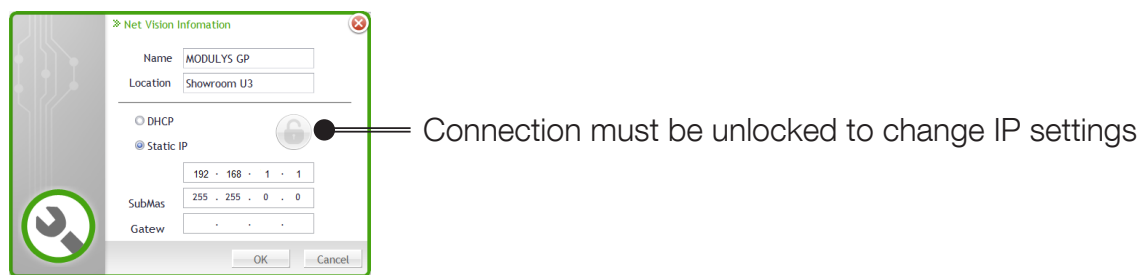

8.2. BROWSE

Click on to start the web browser and open the NET VISION home page.

8.3. FW UPGRADE

Click on  to open the FW upgrade window



If several NET VISION units have been selected, the FW bin file can be updated to all selected NET VISION through batch function.

8.4. NET VISION SETTINGS FILE DOWNLOAD

Click on  to open the configuration file download window

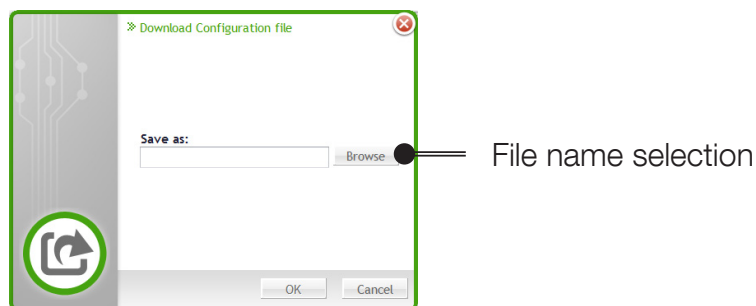

8.5. BATCH OPERATION

Click on  to open the batch operation window

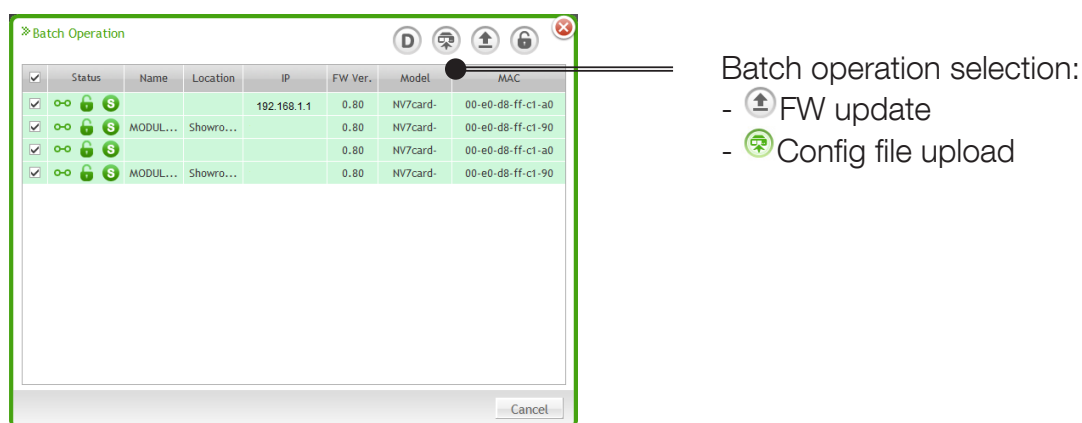

8.6. SUPGRADE.EXE TOOL

 The Supgrade.exe tool used for NET VISION 6 does not recognize the NET VISION 7 / 8 Card.

9. IP ADDRESS CONFIGURATION

9.1. PREPARING NET VISION

Once the UPS power is on and NET VISION has been installed in the COM-Slot and connected to the Network, the NET VISION's IP address must be programmed.

9.2. DEFAULT IP ADDRESS

If a DHCP server is available on the same Network as NET VISION, the NET VISION will request a valid IP address from the server. If the DHCP server is not available, NET VISION switches to the following default IP address: 192.168.7.18.

IPv6 is not activated by default. The default IP address is set to IPv4 format.

9.3. NET VISION ACCESS

When the NET VISION has a valid IP address, open the web browser and enter the IP address set manually or given by the DHCP server. The IP address can be checked with the NET VISION Explorer software utility (see NET VISION explorer §).

NET VISION requests always a login and password account before accessing to web pages. Default admin credentials at first connection:

Login: admin

Password: 6 last Char of MAC address for the first access

After first login, a new password is requested and then a new session login popup appears.

9.4. IP SETTINGS USING NETWORK IF DHCP NOT PRESENT

Even if DHCP is not available, the IP address can be set through the NET VISION Explorer tool.

9.5. IP SETTINGS USING A TERMINAL AND USB FOR NET VISION

The USB Gadget Serial driver must be installed (Windows 10 recognizes the driver automatically - driver installation not necessary). Please refer to the APPENDIX.

Once the device is recognized, open an SSH terminal connection to modify IP settings.

10. RESET NET VISION WITH FACTORY SETTINGS

S1 - Restart Button (H/W): HW reset, Power off/ on

S2 - Reset Button (S/W): SW reset,

Press 1 ~ 3 second: Restart System

Press 3 ~ 6 seconds: Reset Account and Password to Default Value

Press Over 6 seconds: Reset to Factory Default Value

 If functions have been set before this procedure (email, SNMP, Shutdown ...) those functions will need to be reconfigured.

The RESET button does not affect the NET VISION settings, it only restarts NET VISION.

 Make sure that the IP given by the DHCP server remains the same as before the NET VISION RESET.

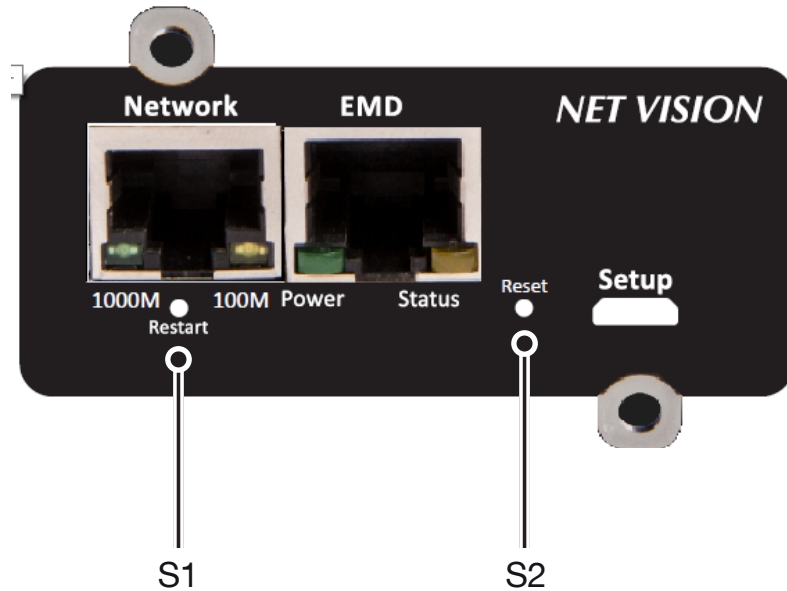

11. NET VISION USER INTERFACE

11.1. NET VISION HOME PAGE

NET VISION system name
NET VISION system location

NET VISION reference UPS Reference Shortcut access Login



The screenshot shows the NET VISION web interface. At the top, there is a header with the Socomec logo and the text 'NET VISION v8.00 SOCOMECS UPS 100.0kVA - P001567817'. Below the header is a navigation menu with options like 'UPS Monitoring', 'UPS Management', and 'History Log'. The main content area is titled 'Comprehensive View' and features a 'UPS tree-view' showing a 'SOCOMECS UPS' icon, a 'UPS synoptic' diagram with a battery icon at '100%' and a load icon at '75%', and a 'Parameters table'.

UPS Parameters	
UPS status	Load protected by Inverter
Output load rate (%)	75/75/75
Output power (kVA)	47.0/46.0/43.0
Output voltage (V)	230/230/230
Rectifier voltage (V)	241/240/242
Battery capacity (%)	100
Remaining Backup time (mn)	23
Battery voltage (V)	584.2
Temperature (°C)	22.0
Date / time	24/11/2017 10:44:04

NET VISION menu UPS tree-view UPS synoptic Parameters table

11.2. NET VISION MENU

11.2.1. UPS MONITORING

UPS monitoring items	Access to	Shortcut access
"Comprehensive view"	UPS synoptic	
"UPS Dashboard"	Synthesis page of UPS parameters displayed by widgets	
"UPS real-time Graph"	Scan function of UPS parameters	
"Client table"	List of Servers connected to NET VISION associated with shutdown client	
"EMD Device"	EMD Environment Device data. It appears if the EMD device is connected to NET VISION.	



11.2.2. UPS MANAGEMENT

UPS management items	Access condition	
"Shutdown management"	Always	
"Battery Test"	If Battery is present The battery test can be applied only if remote controls are enabled by UPS	Controls are available for Read/Write user rights and admin accounts
"Battery Schedule"	If Battery is present and remote controls are enabled by UPS. Available only for 'VU-MAP' UPS	
"UPS control"	If remote controls enabled by UPS	
"eco mode schedule"	If eco mode and remote controls are enabled by UPS	
"Weekly schedule"	If "weekly schedule" is selected in shutdown event	
"Special day schedule"	If "special day" is selected in shutdown event	
"Power Share"	If "Power share" function is present and remote controls are enabled by UPS	
"EMD Device"	If the EMD device is connected to NET VISION	

11.2.3. NET VISION MANAGEMENT

NET VISION management items	Access condition	Remarks
"Date and Time"	Update and synchronize NET VISION and UPS date and time	
"NET VISION Configuration"	General settings	
"NET VISION Control"	Enable or disable network services / protocols	
"Multi-User Table"	Set the users access rights	
"Remote View Pro Configuration"	To activate the connection to Remote View Pro supervision software	RV Pro v3 or above
"SOCOMEc IoT connection"	To activate the connection to SOCOMEc Cloud for digital services	Need to contact SOCOMEc Service before for creating your account and receiving the activation key for your site.
"SNMP v3 Configuration"	SNMP v3 USM table settings	
"SNMP TRAP Receivers"	NMS configuration	
"Email Notification"	SMTP server / emails addresses settings	Items disabled by default. Pages are present if services or protocols have been enabled in NET VISION Control page.
"Authentication Configuration"	RADIUS settings	
"WOL Targets"	Protocol pages settings	
"Modbus TCP Config"		
"Syslog Setup"		
"DDNS Setup"		
"Firewall Setup"		
"External Links Setup"	To add hyperlink for network devices access	
"Multi-Language Setup"		Check on socomec web side for availability
"Firmware Update"		

11.2.4. HISTORY LOG MENU

History Log items		Remarks
"UPS History Log"	NET VISION stores the measurements every 60s by default. 2048 is the maximum of records stored by NET VISION.	 Shortcut access in graphic mode
"UPS Extend History log"	NET VISION stores in this log the minimum, average and maximum of UPS measurements every 1 hour by default; up to 2048 records	 Shortcut access in graphic mode
"UPS event Log"	Store UPS alarms (add and remove)	
"NET VISION Event Log"	Store all actions done on NET VISION	
"Clear and save Logs"	Remove logs from NET VISION memory Download logs to local computer (csv)	

List of measurements stored by NET VISION in "History Log" and "Extend History Log"

"Input voltage"	(V) Per phase	A measurement stored with a value of -1 means that this measurement is not managed by the UPS
"Input frequency"	(Hz * 10)	
"Output load rate"	(%) per phase	
"Output voltage"	(V) per phase	
"Battery capacity"	(%)	
"UPS temperature"	(°C) or (°F)	

11.2.5. EXTERNAL LINK

An extra menu is present if devices have been activated. These links give direct access to other devices. It automatically opens a new page in the web browser with the selected link.

11.3. UPS ARCHITECTURE TREE-VIEW

NET VISION automatically recognizes the UPS topology and adapts the UPS tree-view and synoptic view.

UPS topologies			
Single unit UPS	Modular unit UPS	Modular system Up to 4 units in parallel	Parallel system UPS Up to 10 units in parallel
UPS reference UPS reference Module number Module number 1 2 3	UPS reference Module number Module number 1 2 3	SYSTEM reference Unit number Module number Unit number Module number	SYSTEM reference Unit number Unit number Unit number Unit number
	Modules numbered from 1 to 8, according the physical position in the unit's cabinet	Horizontal Modules numbered from 1 to 24, according the physical position in the unit's cabinet	In case of centralized bypass, the Bypass Unit is not represented

Energy Saver icon is displayed if the mode is activated

Device status management:

Status	Single / modular	System	Unit	Module	Battery
On standby					: disconnected
Operating					: Ok
Operating with alarm					: discharging
Operating with critical alarm					: alarm
Imminent stop (flashing)					
Click for access to:	UNIT SYNOPTIC UNIT TABLE	SYSTEM SYNOPTIC UPS TABLE	UNIT SYNOPTIC UNIT TABLE	MODULE TABLE	

11.4. UPS SYNOPTIC

NET VISION manages 2 types of synoptic: SYSTEM VIEW and UNIT VIEW

System view for parallel systems	
<p>Overviews of units' input and bypass input supply and the global output of the UPS. The UPS output parameters table gives the global measurements of all units that are operating.</p>	
Unit view for single, modular or units as part of a parallel system	
<p>This view gives details of rectifier and bypass inputs supply, battery status and unit output parameters.</p>	

11.5. USER LOGIN

The login status is given by following icons:



Not logged



Logged

Click on the button to open a session or to close the current session.

Login popup:

Admin account management:

- at first connection after installation or after factory reset command, the password is set with the 6 last char of its MAC address
- after first login, the password needs to be changed and a new session needs to be open.

To access to all the configurations and UPS controls, it is necessary to open a session as admin or with a “Read/Write” user access account.

It is possible to set a “Login Timeout (Sec)” in the NET VISION Configuration page. At the end of the timeout, the current session is closed automatically.

NET VISION does not allow more than one session.



If a session is still open, a new session that is opened forces the logout of the previous session.



Password policy : minimum of 12 characters including :

- Upper case letters: A to Z
- Lower case letters: a to z
- Numbers: 0 to 9
- Special char : ! % # @ ^ * (other characters are not allowed)

12. UPS MONITORING

12.1. UNIT SYNOPTIC

12.1.1. SYNOPTIC ANIMATION

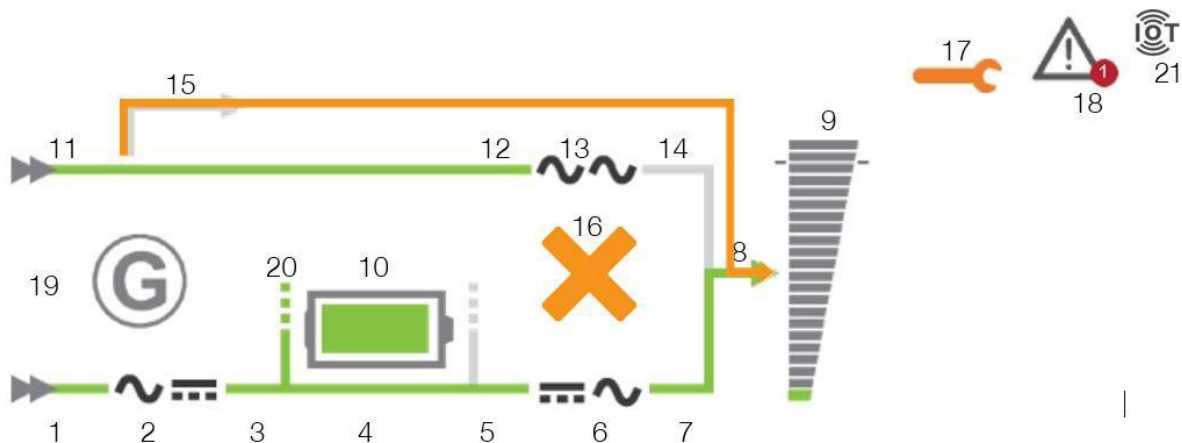

	Element	Grey	Green	Yellow	Red
1	Rectifier input supply	Not present	Present		
2	Rectifier			On + prev. alarm	Critical alarm
3	Rectifier output	Rectifier off	Rectifier on		
4	DC Bus	Rectifier off	Rectifier on		
5	Inverter input	Rectifier off	Rectifier on	On battery	
6	Inverter			On + prev. alarm	Critical alarm
7	Inverter output	Inverter off	Inverter on	On battery	
8	Output	off	On inverter or On eco mode	On bypass or On battery	
9	Load	0%	Up to 90%	Above 90%	Above 100%
10	Battery	default		Battery room or temp, alarm or test failed	Battery alarm
11	Bypass input supply	Not present	Present		
12	Bypass input	Not present	Present	Bypass on	
13	Bypass			On + prev. alarm	Critical alarm
14	Bypass output	Bypass off	Bypass on and eco mode	Bypass on	
15	Maintenance Bypass	present		On maintenance bypass	
16	Bypass impossible			Impossible	Locked
17	Maintenance alarm			Active	
18	Alarm present	If one alarm present			
19	Genset	Genset on			
20	Battery sharing	Present if the battery is shared with all other Units in parallel system			
21	IoT Status	Present if the IoT connection has been enabled			

The output load rate value is reported to synoptic. The load value is not displayed if the maintenance bypass is closed.

During battery charging and battery charged status, the battery capacity value in % is displayed. The capacity value is replaced by the remaining backup time when the battery is discharging.





12.1.2. BATTERY ANIMATION



Battery status	Battery symbol
Battery circuit open	
Battery charged	
Battery discharging	
Battery discharged	
Battery charging	

12.1.3. LOAD ANIMATION

LOAD RATE	0%	10%	50%	90%	100%	120%
Example of values						

12.1.4. UNIT SYNOPTIC NAVIGATION

Clicking on the rectifier , battery , inverter , bypass  and output load  symbols shows the related parameters table below the synoptic.

To switch back to **Unit/UPS Parameters Table** click on  or  button, or select “**comprehensive view**” in the UPS Monitoring menu

Navigation overview

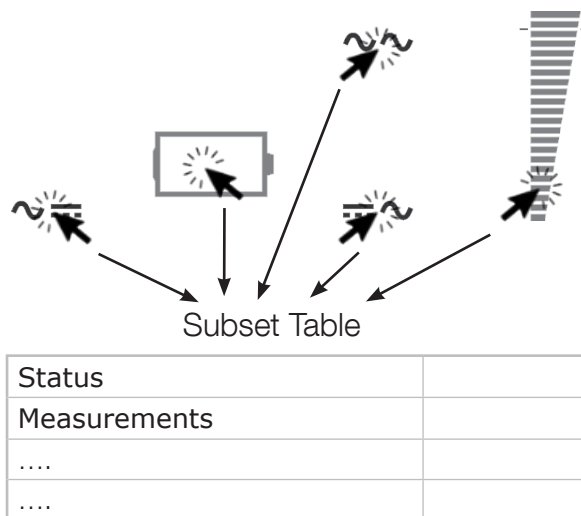

 If one or more alarm is present, clicking on  opens the alarm table. The icon flashes when a new alarm is incoming. In this situation, it opens the alarm page, resets all alarms and stops the audible alarm on UPS.

12.1.5. UNIT / UPS PARAMETERS TABLE

The table is updated with data read from the UPS or from the Unit selected

"UPS or Unit Parameters"		
"UPS Status" The status displayed depends on the type of UPS range. Status lists are not available for all UPS, depending on the range and UPS functionalities		"Unknown" – no communication with UPS "In Service mode" "On maintenance bypass" "Imminent STOP" "Auto-test procedure" "Operating on Battery" "Battery test in progress" "Load protected by Inverter" "Normal mode" – for OFF LINE UPS "UPS in eco mode" "Line-Interactive mode" "Load on Bypass" "Unit Available" "On standby" "Load OFF"
"Output load rate	(%)	Per phase
"Output Power	(kVA)	Global if measurements available from UPS
"Output	(kW)	Global if measurements available from UPS
"Output Voltage	(V)	Per phase
"Input voltage	(V)	Per phase
"Battery capacity	(%)	Only if battery present
"Remaining backup time	(mn)	
"Battery voltage	(V)	
"Temperature	(°C)	UPS ambience temperature
"Date / time"		

12.1.6. BATTERY PARAMETERS TABLE

"Battery Parameters"		
"Battery Status" The status list displayed depends on the type of UPS range. Depending on the range and UPS functionalities, parts of the status list are not managed.		"Unknown" "Battery disconnected" "Battery discharged" "Battery low" "Battery discharging" "Battery to input" – specific function (optional) "Battery alarm" "Battery room alarm" – if sensor present "Battery temperature alarm" – if sensor present "Battery test running" "Battery charging" "Battery OK"
"Battery voltage (V)"		Battery string + and string - values are displayed if present.
"Battery capacity (%)"		
"Battery capacity (Ah)"		
"Remaining Backup time (mn)"		Value present in the table during the battery discharging when computed or indicates the nominal backup time in normal operation
"Battery temperature (°C)"		If the temperature sensor is present (option)
"Time since on battery power (mn)"		Present only during battery discharging

12.1.7. OUTPUT PARAMETERS TABLE

"Output Parameters"		
"Output Status" The status list displayed depends on the type of UPS range. The status list is not available for all UPS, depending on the range and UPS functionalities		"Unknown" – if no com with UPS "On maintenance bypass" "Load protected by inverter" "Normal mode" – for OFF LINE UPS "eco mode" "Load on Bypass" "Line-Interactive mode" "On standby" "Load OFF"
"Output load rate (%)"		Per phase
"Output Power (kVA)"		Present if computed by UPS
"Output Power (kW)"		Present if computed by UPS
"Output power factor"		Per phase if computed by UPS
"Output crest factor"		Global if computed by UPS
"Output Current (A)"		Per phase
"Output Voltage (V)"		Per phase
"Output Voltage (U)"		Per phase if computed by UPS
"Output Frequency (Hz)"		

12.1.8. RECTIFIER PARAMETERS TABLE

"Input Parameters"		
"Input Voltage	(V)"	Per phase
"Input Current	(A)"	Present if computed by UPS
"Input Power	(kW)"	Present if computed by UPS
"Input Frequency	(Hz)"	
"Gen Set Status"		Present if managed by UPS

12.1.9. BYPASS PARAMETERS TABLE

"Bypass Parameters"		
"Bypass Voltage	(V)"	Per phase
"Bypass Voltage	(U)"	Present if computed by UPS
"Bypass Power	(kW)"	Present if computed by UPS
"Bypass Frequency	(Hz)"	

12.1.10. INVERTER PARAMETERS TABLE

"Inverter Parameters"		
"Inverter Voltage	(V)"	Per phase. Set to 0 if inverter is off
"Inverter Voltage	(U)"	Present if computed by UPS
"Inverter Frequency	(Hz)	Set to 0 if inverter is off

12.2. SYSTEM SYNOPTIC

12.2.1. ANIMATION

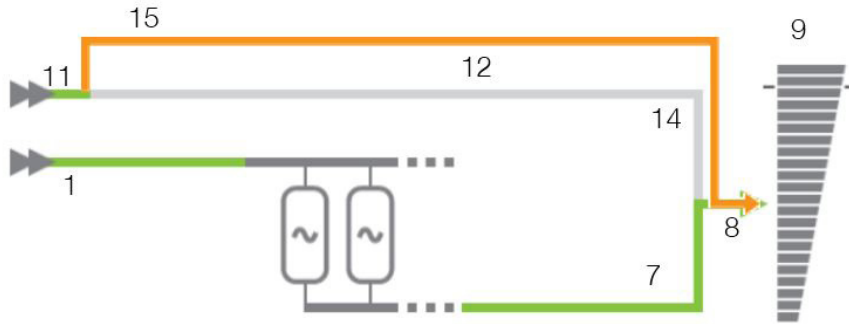

Element	Grey	Green	Yellow	Red
1	Rectifier input supply	Not present	Present	
7	Inverter output	Inverter off	Inverter on	On battery
8	Output	off	On inverter On eco mode	On bypass On battery
9	Load	0%	Up to 90%	Above 90% Above 100%
11	Bypass input supply	Not present	Present	
12	Bypass input	Not present	Present	Bypass on
14	Bypass output	Bypass off	Bypass on and eco mode	Bypass on
15	Maintenance Bypass	Present		On maintenance bypass

12.2.2. NAVIGATION

Clicking on the System  and output load symbols  shows the related parameters table below the synoptic.

Clicking on the  button or “Comprehensive view” in the Monitor menu switches back to the “UPS Parameters Table”.

12.2.3. UPS PARAMETERS TABLE

The table is updated with data read from the UPS at System level, which is a combination from all Unit data.

See “Unit/UPS Parameters”

12.2.4. UPS OUTPUT PARAMETERS TABLE

The table is updated with data read from the UPS at System level, which is a combination from all Unit data.

See UPS “Output Parameters Table”

12.3. ALARM TABLE

The alarm table is accessible by clicking on the  icon. The number associated to the icon  indicates the number of active alarms.

The alarm icon is shown while the general alarm is present.

The alarms table reports the current active alarms and indicates the last incoming alarm. Each alarm is time-stamped when it occurs.

All alarms from the 'JBUSP' (A00 to A63) or 'VU-MAP' (A000 – A127) table are reported in this page.

Alarm Table

Number of Active Alarms		1	
Last Alarm		General Alarm	
Index	Alarm Time	UPS Alarm Description	Level
Axxx or Axx	dd/mm/yyyy hh:mm:ss		Information Warning Critical

For a parallel UPS system, the table shows only active alarms at system level.

13. UPS DASHBOARD

This page gives an overview of UPS parameters through graphical widgets. Measurements not available or not computed are not represented in this page. Output currents are represented in bar-graph. The vertical line defines the nominal amps limit.

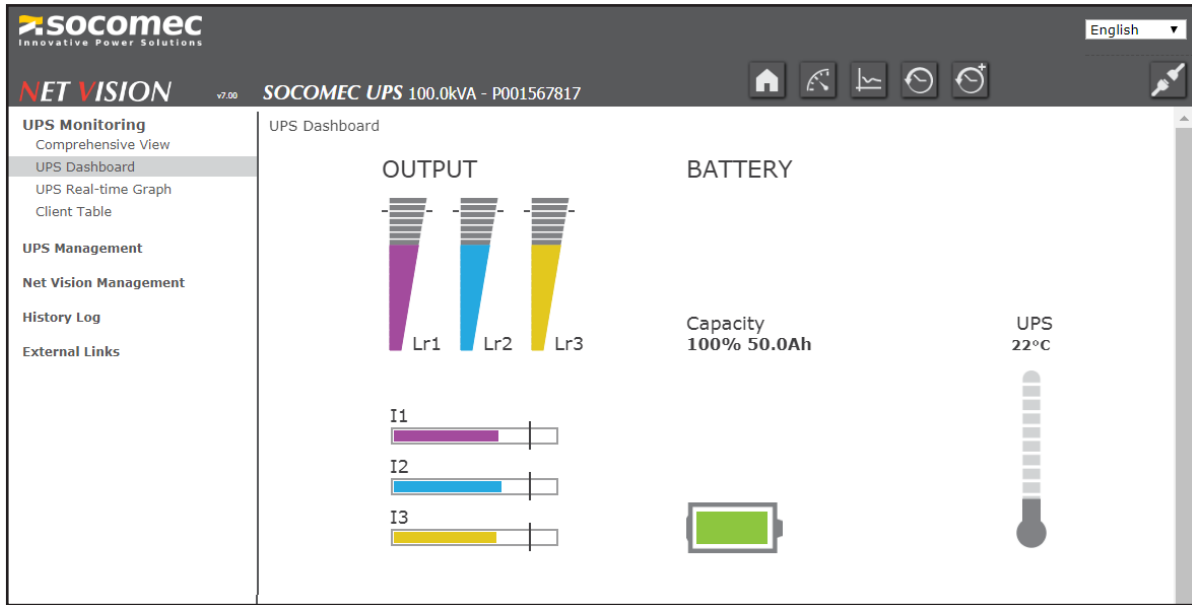

During battery discharging, remaining backup time is displayed

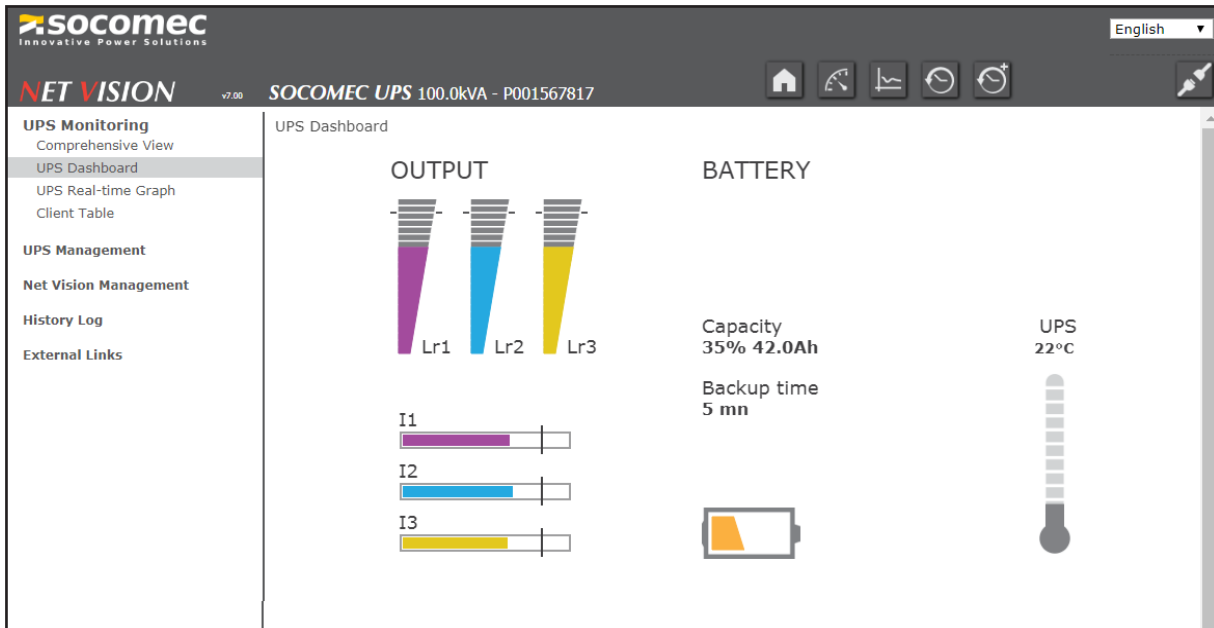

 Go back to synoptic;

For a parallel UPS system, the measurements shown are values read from system level.

14. REAL TIME GRAPH

This widget allows you to scan UPS parameters in real time. Measurements can be selected / unselected for more visibility.

Click on to launch the scanning

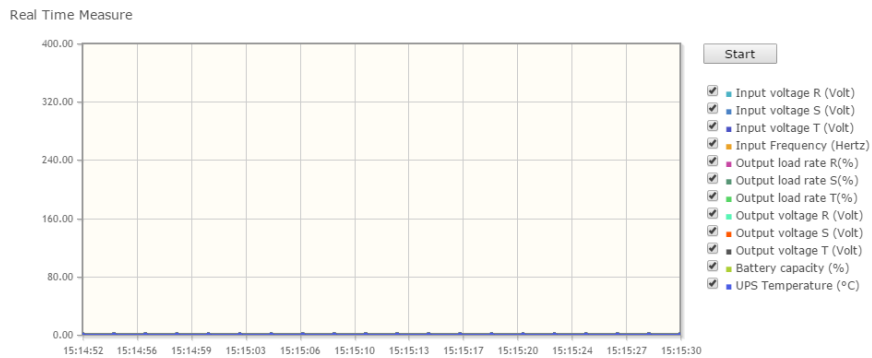

Click on to interrupt the scanning

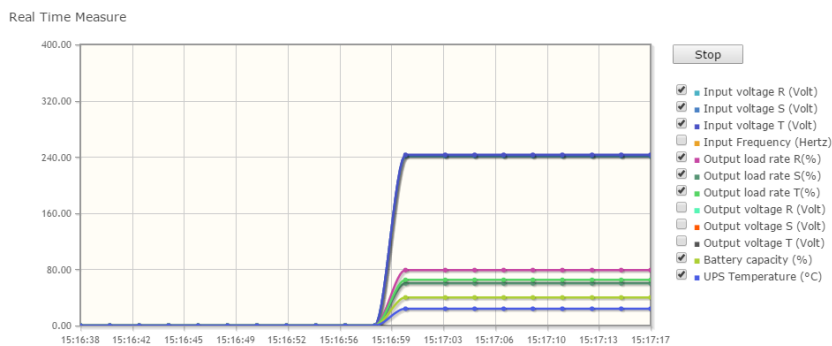

Data scanned not stored by NET VISION



Go back to synoptic;

15. CLIENT TABLE

This page lists all servers / Hosts connected to NET VISION. JNC and VIRTUAL-JNC software shutdown agents have to be installed on all servers to manage the events shutdown sent by NET VISION

Client Table

Connected Client Number	1
-------------------------	---

Index	IP Address	Client Name	Connected Time
1	192.168.1.2	IT Server (JNC)	2017/04/08 11:17:18

16. UPS MANAGEMENT

16.1. UPS CONTROL

If the remote controls are enabled by the UPS, NET VISION allows the following actions depending on UPS capabilities.

The access to the controls page is possible only for admin and read/write account users.

UPS Control

Transfer Load to Bypass	<input type="radio"/>
Enable eco mode	<input type="radio"/>
Enable standby mode	<input type="radio"/>
Alarm Acknowledgement	<input type="radio"/>

Apply

List of all controls managed by NET VISION

"Transfer Load to Inverter"*	Controls are available if all conditions and permissions are set by the UPS. (*) only for DELPHYS UPS ranges If a control is not present, it means that this control is not allowed by the UPS.
"Transfer Load to Bypass"*	
"Enable Line-interactive mode"*	
"Disabled Line-interactive mode"*	
"Enable eco mode"	
"Disable eco mode"	
"Enable standby mode"	
"Disabled standby mode"	
"Alarm Acknowledgement"	Always present

(*) Only for VU-MAP UPS compliancy

For parallel UPS systems, the controls are sent to the system and dispatched to all the units present. NET VISION does not allow sending controls unit by unit.

16.2. BATTERY TEST

This function gives the possibility to send an immediate battery test to the UPS.
The result of the last battery test, if any, is reported in the page.

For single or modular units or parallel systems with shared battery:

Battery Test

Battery test status	Last Battery test*	Result	Next test (in day)	Battery test control
Disabled In progress On standby Programmed Enabled	day/month	No test OK Interrupted Failed	0 if not programmed	<input type="button" value="Apply"/> Available if the remote controls are enabled by the UPS and the battery test is possible

For parallel systems with distributed battery or for unit with blended batteries between modules (only VU-MAP compliancy UPS):

Battery Test

Unit number or battery number	Battery test status	Last Battery test*	Result	Next test (in day)	Battery test control
1	Disabled In progress On standby Programmed Enabled"	day/month	No test OK Interrupted Failed	0 if not programmed	<input type="button" value="Apply"/> Available if the remote controls are enabled by the UPS and the battery test is possible
2	Disabled	00/00	No test	0	

16.3. BATTERY TEST SCHEDULE

This function is available only for VU-MAP compliancy UPS.

The battery test can be programmed automatically to start on a specific day and hours with a frequency given in weeks:

Battery Test Schedule

Week interval	Day	Hours	
<input type="text" value="Disabled"/> <input type="text" value="1"/> <input type="text" value="..."/> <input type="text" value="52"/>	<input type="text" value="Monday"/> <input type="text" value="..."/> <input type="text" value="Sunday"/>	<input type="text" value="00"/>	<input type="button" value="Apply"/> Only if remote controls are enabled by UPS

For parallel systems with distributed battery, the battery test schedule can be programmed unit by unit. Each battery test will be started at different time.

16.4. ECO MODE SCHEDULE

This function is available if the eco mode function is enabled by the UPS.

NET VISION can manage a running period in eco mode, than switches again in normal mode.



Warning: Make sure that the eco mode schedule is not activated on the UPS itself via local control panel before to set the eco mode schedule from NET VISION page. Both schedules cannot run on same time.

Eco mode Schedule

Index	Enabled eco mode	Disabled eco mode	
1	Disabled Monday ... Sunday	00:00	Disabled 00:00

16.5. WEEKLY SHUTDOWN SCHEDULE

This function is activated if the “Weekly Schedule” event is enabled in the “event shutdown management” page.

Weekly Schedule

Index	SHUTDOWN period	RESTART period	
1	Disabled Monday ... Sunday	00:00	Disabled 00:00

16.6. SPECIAL DAY SHUTDOWN SCHEDULE

This function is activated if the “Special Schedule” event is enabled in the “event shutdown management” page.

Special Schedule

Index	SHUTDOWN period		RESTART period	
1	01/01/2017	00:00	01/01/2017	00:00

16.7. POWER SHARE

This function is available if the UPS manages power plugs and remote controls have been activated. The configurations and Plugs controls page is accessible for admin account login only.

Power Share Management

Available Plugs	Mode	Value
Plug 1	<div style="border: 1px solid black; padding: 5px;">None Battery Capacity Remaining backup time Emergency light ON Time since on battery</div>	<div style="border: 1px solid black; width: 100px; height: 20px;"></div>

Power share Plugs	<input type="checkbox"/> 1	<input type="checkbox"/> 2	
-------------------	----------------------------	----------------------------	--

MODE SETTINGS

- "Battery Capacity": switches the output plug to OFF when the value is reached.
- "Remaining Backup time": switches the output plug to OFF when the value is reached.
- "Time on Battery": switches the output plug to OFF when the value is reached.
- "Emergency lighting": switches the output plug to ON when the UPS is on battery.

PLUGS CONTROL

Select to close or unselect to open the plugs then apply.
Plugs are immediately opened or closed according the control sent.



Warning: the UPS ignores the immediate control if the plug is set to a specific mode.

16.8. SHUTDOWN MANAGEMENT

NET VISION allows you to send notification and shutdown commands to servers. The shutdown agent must be installed on each server / Host. The NET VISION IP address should be set in the agent configuration. If the server is recognised by NET VISION, it will be present in the Client Table page of the UPS monitoring menu.

UPS SHUT OFF

This function is available if the Standby Schedule function is managed by the UPS. Otherwise this function is not displayed.

The UPS shut-off command is sent to the UPS when the NET VISION sends the shutdown command to the server. This command is sent with the time period set for this function. The UPS will turn off the output at the end of the time period.

The restart delay defines the time period after which the UPS should restart automatically after mains power resumes. A restart time set to 0 means that the UPS will not restart.

Shutdown Management

UPS Shut Off Delay (Sec)		Request to shut off the UPS after delay
UPS Shut Off	<input type="button" value="Disabled"/> ▼ <input type="button" value="Enabled"/>	
UPS On Delay (mn)		Request to restart the UPS
Level of battery capacity (%)	0 - 100	Set the battery level for event shutdown

Shutdown Event	Shutdown Actions	Warning Period (Min)	1st Warning (Sec)	Warning Interval (Sec)
List of Event	<input type="button" value="Disabled"/> ▼ <input type="button" value="Enabled"/>	Delay in minutes before sending shutdown command to server	Delay in seconds before sending the first warning message to sever	Delay between 2 warning messages sent to server



WARNING!

Make sure that the UPS shut-off time period is longer than the total time period for the shutdown procedure for the Server / Hosts supplied by the UPS. See shutdown process paragraph for more details.

SHUTDOWN SEQUENCE

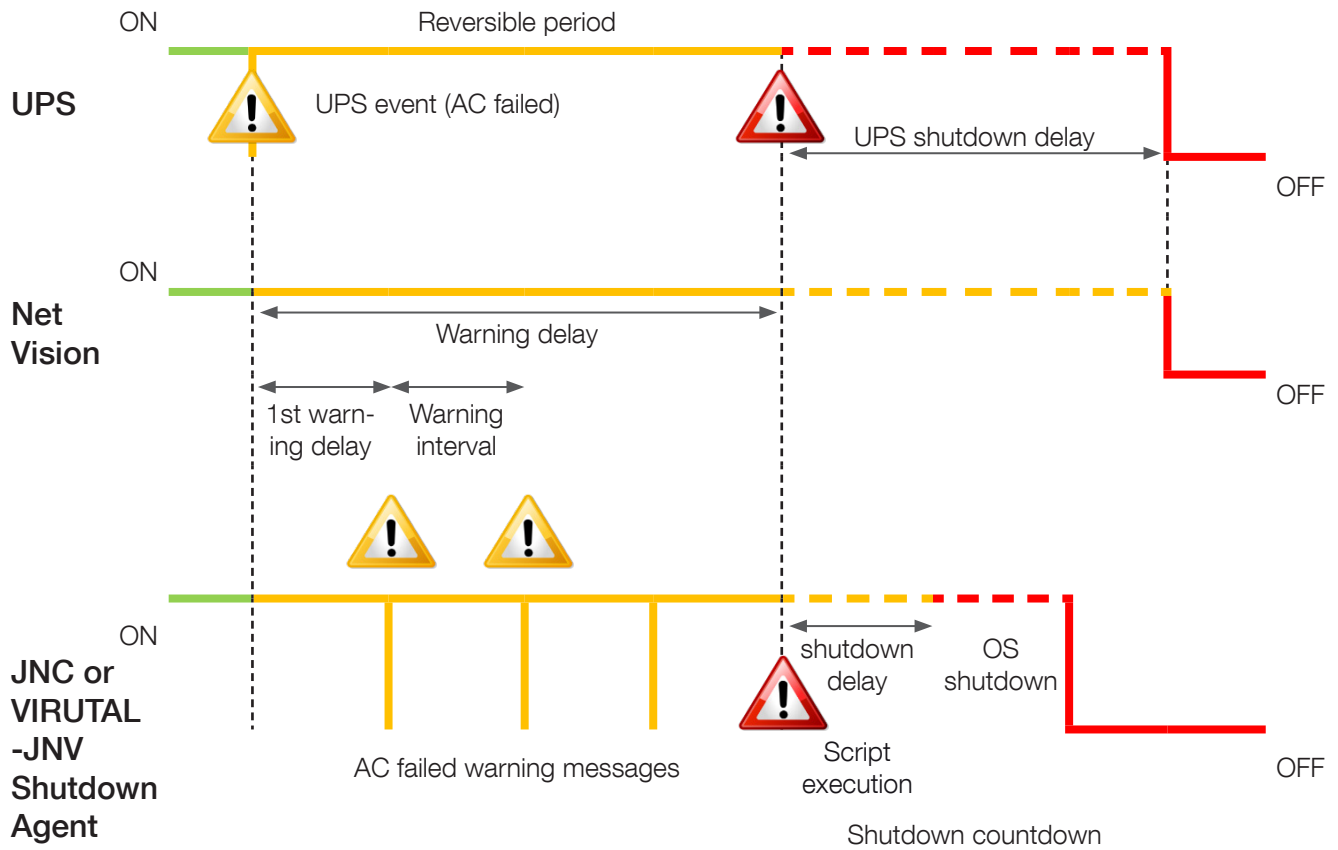

Reversible period:

If the event is removed during this period, the shutdown process is cancelled. At the end of this period, the NET VISION sends the shutdown command to servers and the UPS standby control if enabled.

Shutdown delay:

The Shutdown agent can start running scripts or batch files before the OS shutdown.



UPS shutdown delay must be greater than the server's shutdown time, evaluated as the shutdown delay set on the agent + OS shutdown itself.

SHUTDOWN EVENT SELECTION

- "UPS on battery (AC Failed)"
- "Battery Low or Battery Discharged"
- "Battery Level"
- "Imminent Stop"
- "UPS Overload"
- "Temperature Alarm"
- "On Bypass"
- "Weekly Schedule – activate the Weekly schedule page"
- "Special Day – activate the Special Day Schedule page"

Additional events if EMD device present:

- "EMD Temperature"
- "EMD Humidity"
- "EMD Alarm-1"
- "EMD Alarm-2"

SHUTDOWN TEST PROCEDURE

NET VISION allows you to simulate an AC fail event. After test validation the Shutdown procedure starts, with the settings of 'AC failed' event.

The AC Failed simulation is disabled if the AC Failed Shutdown action is disabled.

NET VISION sends the notification and the shutdown command to the server.

At the end of the procedure, after sending the shutdown command. NET VISION waits around 2 minutes before sending a shutdown cancel command. This command permits the agent to recover normal UPS status. The agent is then ready for the shutdown procedure again.

During the test, the button is disabled and switches to 'enabled' when the 'shutdown cancel' command is sent to servers.

WARNING!



If the Warning period = 0, the server shutdown command is sent immediately.

17. EMD DEVICE MANAGEMENT

If an EMD device (Environment Monitoring Device) is connected to NET VISION, you will need to activate it. The EMD should be connected to the NET VISION EMD port. EMD values are not transferred to the UPS.

Customisation

Temperature and humidity measurements and two inputs can be assigned as required.

Thresholds

The Low and High thresholds define the tolerances. If the value is out of tolerance, NET VISION will send an email, SNMP TRAP or server shutdown command, depending on the NET VISION settings.

The offset can compensate the value with a reference value.

Alarm mode

It defines if the EMD inputs are flagged as an alert in 'Normally Open' or 'Normally Closed' position.

EMD Device

Information

EMD Address	1
Application FW Version	01.00.0005

EMD 1

Location Name	<input type="text"/>	
Alarm-1	<input type="text" value="Alarm-1 Name"/>	Disabled ▼
Alarm-2	<input type="text" value="Alarm-2 Name"/>	Disabled ▼

Sensor	Temperature (°C)	
Sensor Name	<input type="text" value="Temperature Name"/>	
Calibration Offset	<input type="text" value="0.0"/> ▼	
Critical Set Point (High)	<input type="checkbox"/>	<input type="text" value="60.0"/>
Warning Set Point (High)	<input type="checkbox"/>	<input type="text" value="50.0"/>
Warning Set Point (Low)	<input type="checkbox"/>	<input type="text" value="10.0"/>
Critical Set Point (Low)	<input type="checkbox"/>	<input type="text" value="5.0"/>

Sensor	Humidity (%)	
Sensor Name	<input type="text" value="Temperature Name"/>	
Calibration Offset	<input type="text" value="0.0"/> ▼	
Critical Set Point (High)	<input type="checkbox"/>	<input type="text" value="60.0"/>
Warning Set Point (High)	<input type="checkbox"/>	<input type="text" value="50.0"/>
Warning Set Point (Low)	<input type="checkbox"/>	<input type="text" value="10.0"/>
Critical Set Point (Low)	<input type="checkbox"/>	<input type="text" value="5.0"/>

18. NET VISION MANAGEMENT

18.1. DATE AND TIME

UPS date and time

NET VISION allows the synchronisation of the UPS date and time. When NET VISION detects a new date and time (set manually or via NTP server), it sends the new values to the UPS if this function is enabled.

This function is enabled if the date and time are managed by the UPS. Otherwise this part is not displayed.

Update Now sends the current date and time to the UPS manually.

Date and time

Synchronise with computer where the web browser is open

Synchronise with NTP server (every hours)

Set values manually.

NET VISION also manages the time zone; GMT + [x] hours.

Date and Time

Date on UPS (dd/mm/yyyy)		
Time on UPS (hh:mm:ss)		Update Now
Synchronize UPS	Disabled Enabled ▼	Set Value

Date and Time

System Date (dd/mm/yyyy)	
System Time (hh:mm:ss)	

Time Zone

GMT+

Daylight Saving Time:



Disabled



Enabled

Synchronize with computer time

Computer Date:

Computer Time:

Synchronize with NTP server

NTP Server:

IP address

NTP Synchro:

hour / day / week / month

NTS Support:

Disabled
Enabled ▼

Set manually

Date (dd/mm/yyyy):

01/01/2022

Time (hh:mm:ss):

00:00:00



In case of using NTP synchronisation GMT and daylight management are to set according NTP server configuration.
GMT time zone and daylight are often managed by NTP server itself.

18.2. NET VISION CONFIGURATION

Configuration	Default value	Description
"Upload Configuration"		Select the NET VISION settings backup file to restore previous settings
"Upload CA file "		Select a local certificate for secure connection.
"Download Configuration"		Create a backup file of all NET VISION settings
"Download Root Certificate"		Download the NV certificate to install on local computer for secure connection
"Download MIB file"		
"BootP/DHCP"	DHCP enabled	Select "Static" to modify manually IP settings
"IP Address"	192.168.7.18	
"Gateway Address"		
"Subnet Mask"		
"DNS Address"		Allows you to set server IP by name, instead IP value address
"System Name"	Socomec	Name reported in NET VISION top bar, SNMP OID and in email
"System Contact"		Additional info reported in SNMP OID and in email
"System Location"		Additional info reported in NET VISION top bar, SNMP OID and in email
"History Log Interval (s)"	60	NET VISION records measurements in history log file every minute (60s). Up to 2048 records
"Extend Log Interval (mn)"	60	NET VISION records the minimum, average and maximum measurements history log file every hour (60mn). Up to 2048 records
"Net Vision admin Password"		To change admin account password
"Polling Rate (s)"	2	Defines the delay between 2 pollings
"First Login Reset (Day)"	90	Accounts password validity period up to 720 days
"Serial Timeout (ms)"	20 ms (56k) 50 ms (19200) 100 ms (9600)	Additional serial time out
"Temperature unit"	°C	Select °C or °F
"SNMP read Community"	public	To be reported in the NMS if necessary
"SNMP write Community"	private	To be reported in the NMS if necessary
"Login Timeout (s)"	300	Defines the time while the session is open.
"Baud rate Setting"	9600	Can be changed if automatic discovery is not working. 2400 / 9600 / 19200 / 57600

"IPv6 Configuration"	Automatic	Select the IPv6 mode
"IPv6 Local Address"	fe80::2e0:d8ff:feff:c1a0/64	To be set according to IPv6 settings
"IPv6 Global Address"		To be set according to IPv6 settings
"IPv6 Router"		To be set according to IPv6 settings

18.3. NET VISION CONTROL

Configuration	Default value	Description
"BootP/DHCP"		
"PING Echo"		The ping answer can be disabled
"Network Upgrade"		The FW upgrade, through TFTP, from NET VISION Explorer can be disabled.
"HTTPs Port"	Port 443	To enable HTTPs secure connection
"HTTP Port"	Port 80	To enable web page and changing port
"SSH Connection"	Port 22	To enable remote console (such as putty tool) for NET VISION configuration
"SNMP Support"	Port 161 Version	To enable connection to NMS v1 / v2c / v3
"SMTP Support"	Port 25	To enable email functions
"UPnP Control"		To enable NET VISION as a Network device
"RADIUS/Authentication"		To enable authentication protocol page settings
"WOL Target"		To enable Wake On LAN settings page. Protocol to restart servers when NET VISION restarts after a shutdown due to AC failure.
"Modbus Configuration"		To enable MODBUS TCP protocol
"Syslog Setup"		To enable Syslog settings page
"DDNS Setup"		To enable DDNS settings page
"Firewall Setup"		To enable Firewall settings page
"SNMP Unit Select"	0 for System Unit 1 to 12	0 to populate all SNMP OID with UPS data at system level. Set to unit number to populate all SNMP OID with the local UNIT data where the NET VISION is connected. NET VISION must be installed on each Unit. TRAPS are still managed at SYSTEM level.
"SNMP TRAP / email Filter"	Disabled	This function enable or disable TRAP3 and TRAP4 notification when "severity" level is set as filter to send TRAP or e-mail.

18.4. MULTI-USER TABLE

This table sets user's credential to access the NET VISION interface, NET VISION allows up to 8 user accounts.

Admin account is not managed in this table, this account is always active.

Multi-User Table

Index	User Name	Password	Access type
1	<input type="text"/>	<input type="text"/>	Disabled Read Only Read/Write

Remark:

This table combines with the RADIUS function. NET VISION checks before on RADIUS server (if enabled) the user account. If the user is existing on RADIUS server, NETVISION will take the RADIUS account credentials. Otherwise he will check the local user account set in the Multi-User table.

18.5. REMOTE VIEW PRO CONFIGURATION

If Remote View Pro supervision SW is running to monitor the UPS, the server IP must be reported in NET VISION.

Remote View Pro SW sees NET VISION as a communication node server.

NET VISION must be added on Remote View Pro accordingly.

Remote View Pro Configuration

Server Control	Disabled Enabled
Server IP	<input type="text"/>
Server Port	80
GUID	NV MAC address
Password	To set

18.6. REMOTE VIEW PRO SERVER CONFIGURATION

This function is available from Remote View Pro v3.x version. Previous release has to be updated with last package available on SOCOMEC's WEB page. A new licence is not needed if already installed. The configurations are reported in the new release during installation setup.

A new group has to be created in "Device Group" as NV7 type.

- Select a Name for this group
- Copy the GUID given by NET VISION
- Set the same password as in NET VISION
- Apply to save settings.

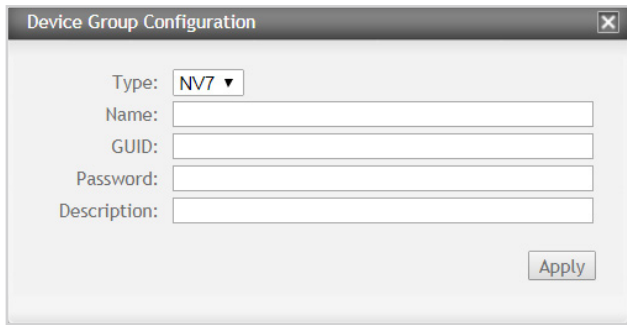

The image shows a dialog box titled "Device Group Configuration". It contains the following fields and controls:

- Type: NV7 (dropdown menu)
- Name: (text input field)
- GUID: (text input field)
- Password: (text input field)
- Description: (text input field)
- Apply (button)

Once the new Device Group is connect, Add the NET VISION in Node List

If an EMD device is connected to this NET VISION, EMD device has to be added as a second node.

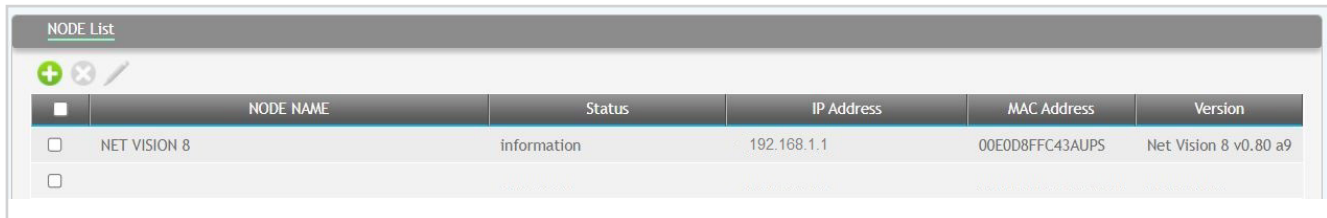

The image shows a window titled "NODE List" with a table of nodes. The table has the following columns: NODE NAME, Status, IP Address, MAC Address, and Version. There are also icons for adding (+), deleting (x), and editing (pencil) nodes.

	NODE NAME	Status	IP Address	MAC Address	Version
<input type="checkbox"/>	NET VISION 8	information	192.168.1.1	00E0D8FFC43AUPS	Net Vision 8 v0.80 a9
<input type="checkbox"/>					

18.7. SNMP v3 USM TABLE CONFIGURATION

This page contains the related setting for configuring the SNMPv3 protocol.
The security level defines the access for authentication and privacy password.

“noAuthNoPriv” with no authentication and no privacy passwords

“authNoPriv” with authentication password but no privacy password

“authPriv” with authentication password but with privacy password

User name and Password⁽¹⁾ set to NET VISION must be reported in the SNMP v3 configuration of the NMS.
If Authentication is requested, the protocol must be chosen between HMAC-MD5 or HMAC-SHA
If Privacy protocol is requested, the protocol must be chosen between DES or AES.

The protocols chosen in NET VISION must be reported in the SNMP v3 configuration of the NMS

SNMP USM table Configuration

Index	User Name	Auth-Password	Auth-Protocol	Priv-Password	Priv-Protocol	Security level
1	<input type="text"/>	<input type="text"/>	MD5 SHA ▼	<input type="text"/>	DES AES ▼	noAuthNoPriv ▼ authNoPriv authPriv

18.8. SNMP TRAP RECEIVERS CONFIGURATION

This page lists the parameters for SNMP trap receivers. NET VISION allows up to 8 NMS IP Address.
As NET VISION manages its own MIB file and the standard RFC1628 MIB, you have to select the correct MIB file used to monitor the UPS.

In case of using the NET VISION MIB file, a specific filter for TRAP sending can be applied as following:

- Filtering by Severity: in this case a second filter can be applied such as:

“Information”: all TRAPs will be send

“Warning”: ‘warning’ and ‘critical’ TRAPs will be send

“Critical”: only ‘critical’ TRAPs will be sent.



TRAP 3 and TRAP 4 will be not sent with this filter if “SNMP TRAP Filter” has been enabled in the “NET VISION Control” page.



In case of selecting TRAP v3, the USER name of USM table has to be reported in Community string.

- Filtering by Event: it is necessary to select events that will send TRAP to the NMS.



Once events have been selected or unselected, the selection must be saved: click on [Apply](#) to save the SNMP settings

[Apply](#)

SNMP Trap Receivers Table

Index	NMS IP address	Community String	Trap Type	Trap Version	Event Filter	Severity
1	<input type="text"/>	<input type="text"/>	None ▼ RFC1628 NET VISION TRAP	v1 ▼ v2c v3	By Severity	Information ▼ Warning Critical
2					By Event	Event Select

(1) For all passwords, ()[]{}\$%&\|/ characters are NOT allowed"

For SNMP v3 Trap Version, the USM table must be set according to the NMS configuration. Filter by specific event: TRAP list selection ordered by severity.

INFORMATION

This trap is sent upon completion of a UPS diagnostic test	Not available for all UPS
The UPS status is normal. Load protected by UPS (*)	TRAP 22
Alarm cancelled. All alarms are disabled (*)	TRAP 24: General alarm no longer present
The UPS has cancelled the shutdown procedure to agent	TRAP 26: Sent if the server shutdown has been enabled
This trap is sent each time an alarm is removed from the alarm table	TRAP 4: entry removed
The Input supply has been restored	TRAP 23
The communication between UPS and the agent has been restored	TRAP 25
NET VISION is restarting	TRAP 27
EMD Sensor Not over high temperature	TRAP 31
EMD Sensor Not over high humidity	TRAP 35
EMD input2 is restored	TRAP 39
EMD Sensor Not under low temperature	TRAP 29
EMD Sensor Not under low humidity	TRAP 33
EMD input1 is restored	TRAP 37

WARNING

The UPS is operating on battery power	TRAP 1: Sent every minute with remaining backup time
The UPS output is in overload (*)	TRAP 6: Output load rate more than 100%.
The battery is in alarm	TRAP 11
The battery test has detected a weak battery	TRAP16: Test failed
Load supplied by automatic Bypass	TRAP 18: On bypass and not eco mode activated
A warning message has been sent to shutdown agent	TRAP 20: Sent if the server shutdown has been enabled
This TRAP is sent each time an alarm is inserted into the alarm table	TRAP 3: New entry added
Redundancy is lost	TRAP 7
The UPS has switched to battery backup power (*)	TRAP 15: Battery discharging – sent once
The UPS internal temperature has reached the threshold	TRAP 17
A preventive alarm has been detected by the UPS (*)	TRAP 19 (including general alarm)
A shutdown command has been sent to agent	TRAP 21: Sent if the server shutdown has been enabled

CRITICAL

The UPS is about to switch off the output power	TRAP 5: Imminent stop
The battery has been detected as discharged	TRAP 9
A critical alarm has been detected on the UPS (*)	TRAP 12
UPS is no longer communicating with the agent	TRAP 14
The battery has been disconnected from the UPS	TRAP 8
The battery is near of the end of backup time (*)	TRAP 10: Battery low / end of backup time
The load has been disconnected from the UPS	TRAP 13: Load off or on standby mode
EMD Sensor detected low temperature	TRAP 28
EMD Sensor detected low humidity	TRAP 32
EMD input1 is active	TRAP 36
EMD Sensor detected high temperature	TRAP 30
EMD Sensor detected high humidity	TRAP 34
EMD input2 is active	TRAP 38

(*) typical setting for basic usage example, with TRAP filter setting enabled in NET VISION Control page.

18.9. EMAIL NOTIFICATION

This page gives the description of UPS email notification settings. Email sending follows the same rule as for TRAP management.

The first part is dedicated to Mail Server and user account if necessary.

"Mail Server"	IP address or server full name
"User Account"	Needed if authentication is enabled
"User Password" ⁽¹⁾	Needed if authentication is enabled
"Sender email Address"	name@domain
"Mail Subject Prefix"	Free text as mail subject
"DNS Address"	
"Mail Daily Status Report at (hh:mm)"	00:00
"Mail support TLS"	To enabled if required by e-mail server
"Mail support authentication"	To by enabled if user account is required
"Delay before sending (minute)"	delay before sending email if event still present

(1) For all passwords, ()[]{}\$%&\|/ characters are NOT allowed"

Send Test function

Once the Mail Server and account have been set and saved on NET VISION, click on to test the configuration with function.

Mail Type

"Events": the email is sent when the event occurs

"Daily Status": NET VISION sends a daily e-mail at defined time. This e-mail includes history log files in attachment.

"Events / Status": an e-mail is sent when the event occurs with the history log file in attachment.

Event filter by severity:

"Information": all alarms are sent via email

"Warning": alarms tagged as "warning" and "critical" are sent

"Critical": only critical alarms are sent

Event filter by specific event:

Refer to SNMP TRAP event selection.

Selecting this filter means the emails are sent at the same time as SNMP TRAP.

Refer to event list for TRAP

Email Notification

Index	Mail account	Description	Mail Type	Event Filter	Event Level
1	<input type="text"/>	<input type="text"/>	<div style="border: 1px solid black; padding: 2px;"> None ▼ Events Daily status Events/status </div>	<input type="button" value="By Severity"/>	<div style="border: 1px solid black; padding: 2px;"> Information ▼ Warning Critical </div>
...8	<input type="text"/>	<input type="text"/>	<div style="border: 1px solid black; padding: 2px;"> None ▼ </div>	<input type="button" value="By Event"/>	<input type="button" value="Event Select"/>

Note: the e-mail address length is limited to 64 characters.

18.10. AUTHENTICATION CONFIGURATION

This page gives the description of Authentication Configuration settings.

"UDP Port"	This parameter displays the RADIUS protocol port.
"Primary Server"	Primary RADIUS server IP or domain name.
"Secondary Server"	Backup RADIUS server IP or domain name. If the RADIUS server is not backed-up the parameter can remain blank.
"Share Secret of Primary Server"	This parameter is used to transmit an encryption password between NET VISION and primary RADIUS server. This value must be the same as the primary RADIUS server setting.
"Share Secret of Secondary Server"	This parameter is used to transmit an encryption password between NET VISION and the secondary RADIUS server. This value must be the same as the secondary RADIUS server setting. If the RADIUS server is not backed-up the parameter can remain blank.
"Packet Timeout Interval"	When the RADIUS server does not respond within time interval, the authentication packet will be re-sent.
"Packet Retry Times"	When the RADIUS server does not respond the authentication request will be re-sent according to packet retry times.

If you do not have a secondary radius server, you can only set "Primary Server" and "Share Secret of Primary Server".

Authentication Configuration

UDP Port	1812
Primary Server	<input type="text"/>
Secondary Server	<input type="text"/>
Share Secret of primary Server	
Share Secret of secondary Server	
Packet Timeout	<input type="text" value="1"/>
Packet Retry	<input type="text" value="3"/>

Index	User Name	Access type
1	<input type="text"/>	<input type="button" value="Disabled"/> <input type="button" value="Read Only"/> <input type="button" value="Read/Write"/>

Note:

This service allows all users set in the RADIUS server to login to NET VISION with Read/Write permission. Users managed by RADIUS server have to be reported in the User table to select user's rights access to NET VISION (Read or R/W).

18.11. WOL TARGETS

The "Wake On LAN" function restarts through network interface all registered client servers. Up to 32 MAC client addresses can be managed by NET VISION. WOL frame is sent to servers in case of servers have been shut down after an AC failed procedure.

Wake On LAN Targets

Repeating Times	<input type="text" value="1"/>
Interval Timer (s)	<input type="text" value="1"/>

Test	Index	Mac Address	Control	Description
<input type="checkbox"/>	1	<input type="text" value="00:00:00:00:00:00"/>	Enabled ▼	<input type="text"/>

18.12. MODBUS TCP CONFIGURATION

This page enables or disables the MODBUS TCP protocol; the MODBUS Port can be changed.

MODBUS Configuration

Modbus TCP Configuration	Enabled ▼ Disabled
Modbus Port	<input type="text" value="502"/>

Refer to Annex for UPS data access through MODBUS TCP protocol.

Note:



Only 1 unique connection allows

No multi connection

If the MODBUS TCP port has been opened by the remote station and there is a "blank" of 1 minute (no data exchanged), NET VISION will close the port for security reason.

18.13. SYSLOG SETUP

This page contains the related setting for configuring the Syslog protocol

Syslog Setup

Server Control	Enabled ▼ Disabled
Server IP	<input type="text"/>
Syslog filter	UPS + NET VISION + SERVICE
Server Port	514
TLS Control	Enabled ▼ Disabled

Syslog filter: UPS + NET VISION + SERVICE to select the group of events send to Syslog server.

Syslog protocol includes all UPS events, NET VISION configurations changes and shutdown command sent to servers.

All records of UPS Events Log and NET VISION Events Log are pushed to target server through syslog protocol.

Using SYSLOG over TLS, the related certificate can be uploaded if needed.

18.14. DDNS SETUP

This page lets the Administrator to set DDNS configuration in NET VISION.

NET VISION can register any of the DDNS providers.

The user name and password must be created with the selected DDNS provider.

DDNS Setup

DDNS State Disabled / Failed / Pass	
DDNS Control	Enabled ▼ Disabled
DDNS ISP setup	ezip ▼ pgpow dhs dyndns dyndns-stat tzo easydns
User Name	<input type="text"/>
Password	<input type="text"/>
DDNS Domain name	<input type="text"/>

18.15. FIREWALL SETUP

This page allows setting the accessible IP list.

Prefix Length: number of bits in the mask to define the IP segment

Example: /8 = 11111111 00000000 00000000 00000000

Firewall action:

Accept: this IP or IP segment can be accessed by NET VISION.

Reject: this IP or IP segment cannot be accessed by NET VISION.

Firewall Configuration

Index	IP Address	Prefix Length	Action
1	<input type="text"/>	0 to 31 (IPv4) ▼ 0 to 128 (IPv6)	Accept ▼ Reject

18.16. UPnP PROTOCOL

UPnP (Universal Plug and Play) protocol allows NET VISION to be managed as device network from a remote computer.

The user interface can be opened clicking on the NET VISION device icon.

The NET VISION is present in the device network list as bellow.

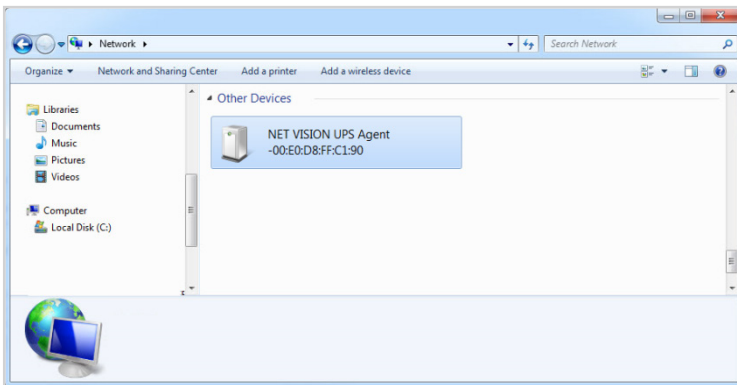

NET VISION network device properties :



18.17. MULTI-LANGUAGE

create your own language version or download additional language package if available.

18.18. FIRMWARE UPGARDE

Upgrade the firmware

select the bin file

click on upload

19. NET VISION IOT GATEWAY

NET VISION includes IoT Gateway functions for:



- SoLive UPS
SOCOME C free mobile app for UPS remote monitoring

- SoLink Remote Maintenance
SOCOME C 24/7 Remote Monitoring Service contract



19.1. REQUIREMENTS

An internet access from the local network is necessary to connect NET VISION to SOCOME C Cloud Application.

NET VISION needs following outgoing ports open:

- HTTPs: 443
- NTP: 123

19.2. IoT GATEWAY ACCOUNT CREATION

Your NET VISION device and the UPS associated have to be created with your own account on SOCOME C Cloud Application.

After contacting your Socomec support you will get an activation key back.

This key has to be reported in NET VISION IoT Configuration page to enable the communication with cloud application.

19.3. NTP SETTINGS

To guarantee the correct data transferring and storage to SOCOME C Cloud Applications, the NTP server has to be set on NET VISION. A public NTP server url, such as ntp.pool.org, is allowed.

19.4. PROXY SETTING

A PROXY server is recommended to ensure a secure internet connection. NET VISION manages different kind of PROXY server.

SOCOMEc IoT connection

Proxy Server	Auto
Host	Disabled
Port	NTLM
Login	Kerberos
Password	Proxy basic

Apply Test

PROXY Settings:

- Select the type of Server
- Enter Host name and port.
- Login and password if needed.

Finalize the setting clicking on **Apply**

Test button checks if the NET VISION is able to reach the Socomec server.

In case of test failed:
Check the PROXY setting and network connection.

19.5. SYNCHRONIZATION

A synchronization action has to be performed to initiate the provisioning process to SOCOMEc's Cloud Application.

The **Synchronization** button is enabled if all following conditions are respected:

- PROXY server enabled if needed
- IoT connection enabled and Activation Key entered
- NTP server set, date and time update from server done once
- UPS is communicating with NET VISION (Serial number and UPS ID and configuration transferred to NET VISION)

Status	Disconnected
--------	--------------

Synchronization

The IoT connection status is above the Synchronization button. (Refer to §19.6.3)

19.6. IoT SERVICE ACTIVATION

IoT Socomec		Enabled ▾	Access Type
Device name		<input type="text"/>	
Remote Maintenance Activation Key		<input type="text"/>	Enabled ▾
Remote Portal Access Activation Key		<input type="text"/>	Disabled ▾
Mobile App	Activation key	<input type="text"/>	Disabled ▾ <input type="button" value="Request"/>
	Site name	<input type="text"/>	Activation key will return via SMS QR code to scan from SOCOMEC APP
	Installation name	<input type="text"/>	
	User reference	<input type="text"/>	
	Admin account email	<input type="text"/>	
	User 1 account email	<input type="text"/>	
	User 2 account email	<input type="text"/>	
	User 3 account email	<input type="text"/>	
User 4 account email	<input type="text"/>		

19.6.1. IoT CONNECTION SETTING

Before to enable a cloud service:

- Enable the IoT Connection
- Enter a Device Name in upper case and without space.

19.6.2. SoLINK : REMOTE MAINTENANCE ACTIVATION

- Enter the activation key (uuid – 32 characters format) given by our Expert Service
- Enable the Remote maintenance service.

and

19.6.3. PORTAL ACCESS ACTIVATION

- Enter the activation key (uuid – 32 characters format) given by our Expert Service
- Enable the Portal Access service.

and

19.6.4. SoLIVE : MOBILE APP ACTIVATION

please refer to Solive quick start guide to monitor your UPS in SoLive mobile app procedure; in brief:

1. Create your Socomec cloud account via UPS App
2. Register your mobile to cloud platform via SoLive UPS App
3. Get the mobile App activation key via SMS
4. Activate your UPS via NET VISION IoT page
5. Add your UPS in Solive UPS App

19.6.5. LIST OF STATUS CONNECTION AND EVENT STORED IN NET VISION EVENTS LOG

Connection Status	description	Action
Device Unknown	The IoT connection is disabled	Default status
Disconnected	The IoT connection stopped	Waiting the next synchronization if the function is enabled
Connecting	The IoT connection is in progress	Wait for connected status
Connected	The IoT connection operates	Normal operation
Create Device Gateway Fail	The gateway provisioning has been refused by the server, or end of time out	Check the IoT settings and enter again the activation key. A new synchronisation has to be start
Create UPS Fail	The UPS provisioning has been refused by the server, or and of time out	A new synchronisation is required
Check Profile Fail	The profile is missing	Click again on [Synchronization], re-starting the process
Download Profile Fail	The profile is corrupted	Click again on [Synchronization], re-starting the process
Push Data Fail	Error answer from server	Wait next data push
SSL CA Expired	No internet access	Check Ethernet connection and proxy settings
DNS Resolved Failed	DNS not reachable	Check proxy setting
Cloud Request Failed	Error get from server	Wait next synchronization
Data check error	Error get from server	Wait next synchronization
Get Gateway Failed	Error get from server	Wait next synchronization
Get UPS Failed	Error get from server	Wait next synchronization

In case of connection failure NET VISION closes all IoT connections, and retries a new connection every 2 minutes. After 10 unsuccessful retries, the NET VISION tries again after 20 minutes. Alarms and Status occurring during disconnection period are memorized and transmitted once the IoT connection is established.

20. EXTERNAL LINK SETUP

This page allows setting the access to other network devices by hyperlink.

Screen Text description will appear in the External Links menu.

The hyperlink includes the IP address or url (without http://) set as Link Address

External Links Setup

Index	Screen Text	Link Address	Status
1	<input type="text"/>	<input type="text"/>	Disabled Enabled
2	<input type="text"/>	<input type="text"/>	Disabled ▼
3	<input type="text"/>	<input type="text"/>	<input type="text"/>
4	<input type="text"/>	<input type="text"/>	<input type="text"/>

Example:

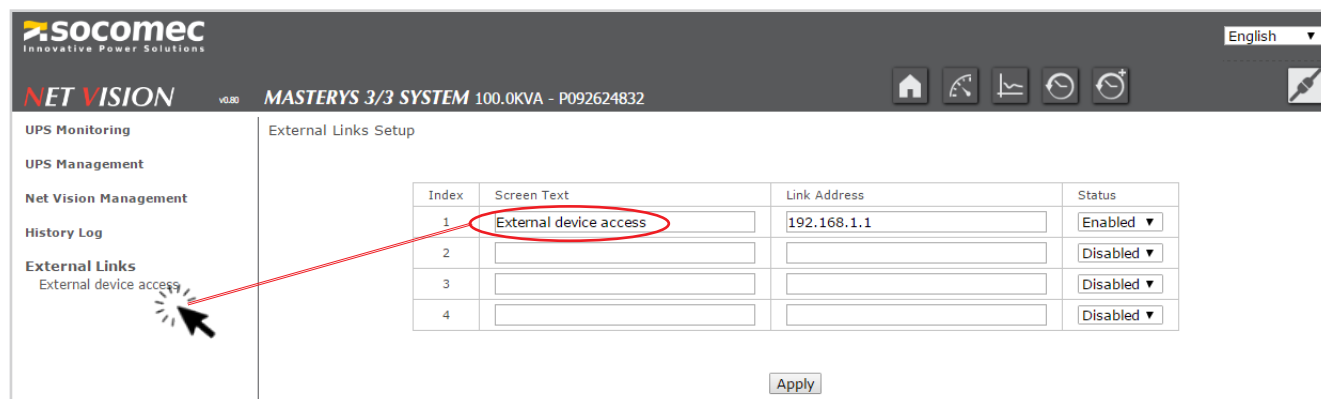

The screenshot shows the Socomec Net Vision web interface. The left sidebar contains a menu with the following items: UPS Monitoring, UPS Management, Net Vision Management, History Log, and External Links. The 'External Links' item is selected, and a red arrow points to the 'External device access' link in the table. The main content area displays the 'External Links Setup' page with a table and an 'Apply' button.

Index	Screen Text	Link Address	Status
1	External device access	192.168.1.1	Enabled ▼
2	<input type="text"/>	<input type="text"/>	Disabled ▼
3	<input type="text"/>	<input type="text"/>	Disabled ▼
4	<input type="text"/>	<input type="text"/>	Disabled ▼

Apply

Click on the link to open a new page in the web browser.

21. HISTORY LOG

21.1. HISTORY LOG

HISTORY LOG ACCESS FROM SHORT CUT IN TOP BAR

From this access, the measurements recorded are shown in graphical mode.

By default, the NET VISION shows the last 30 minutes records.

The time window can be selected by Specific Period or by Day Selection using the calendar function.

Measurements group selection: (all groups are selected by default)

Input Information: includes Input voltage per phase and input frequency

Output information: includes output voltage per phase, global output load

UPS information: includes UPS temperature and battery capacity

UPS History Graphic

<input type="radio"/>	Show	Specific Period ▼	Records
		30 minutes 60 minutes 3 hours 6 hours 12 hours 1 day	

<input type="radio"/>	Show	dd/mm/yyyy	to	dd/mm/yyyy	Records	<input type="button" value="Change"/>
-----------------------	------	------------	----	------------	---------	---------------------------------------



<input checked="" type="checkbox"/> Input information	<input checked="" type="checkbox"/> Output information	<input checked="" type="checkbox"/> UPS information
---	--	---

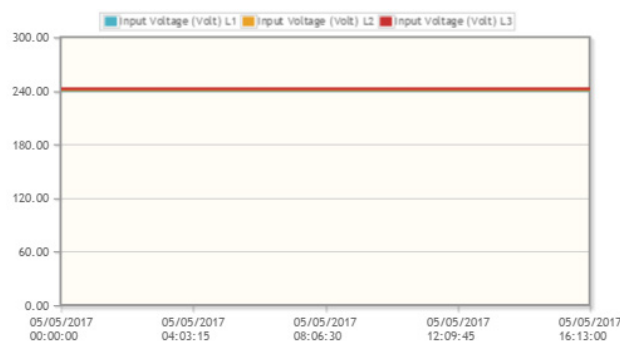

HISTORY LOG FROM NET VISION MENU ITEM

This menu shows the history log page by page in a table presentation.
The last 5 records are shown in the table by default.

The time window can also be changed via the calendar.

The number of pages available is displayed above and below the table. Page numbers are used as buttons to change the log page.

UPS History Log

from to

Log count per page

<< < 1 2 3 > >>

Log	Input Voltage (V)			Output Voltage (V)			Input frequency (Hz)	Output Load (%)			Battery Capacity (%)	UPS temperature (°C)
	R	S	T	R	S	T		R	S	T		
Date time												

<< < 1 2 3 > >>

Maximum number of records: 2048

If the sample is set to 1 minute, the complete time window offers a view of 2048 minute (~1 day and 18 minutes)

21.2. UPS EXTENDED HISTORY LOG

ACCESS FROM SHORT CUT IN TOP BAR

From this access, the measurements recorded are shown in graphical mode.

For each measurement, NET VISION stores the minimum, average and maximum values during the sample rate (60 minutes by default)

By default, the NET VISION shows the last 30 minutes records. It could be that the NET VISION shows “No Record!” due to the sample rate; in such a case, another period must be chosen to have data in the table.

The time window can be selected by Specific Period or by Day Selection using the calendar function.

Measurements group selection: (all groups are selected by default)

Input Information: includes input voltage per phase and input frequency

Output information: includes output voltage per phase, global output load

UPS information: includes UPS temperature and battery capacity

UPS Extended History Graphic

<input type="radio"/>	Show	Specific Period ▼	Records
		30 minutes	
		60 minutes	
		3 hours	
		6 hours	
		12 hours	
		1 day	

<input type="radio"/>	Show	dd/mm/yyyy	to	dd/mm/yyyy	Records	Change

May 2017						
Su	Mo	Tu	We	Th	Fr	Sa
	1	2	3	4	5	6
7	8	9	10	11	12	13
14	15	16	17	18	19	20
21	22	23	24	25	26	27
28	29	30	31			

<input checked="" type="checkbox"/> Input information	<input checked="" type="checkbox"/> Output information	<input checked="" type="checkbox"/> UPS information
---	--	---

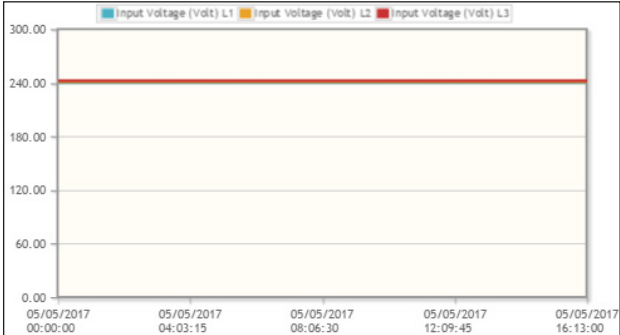

The graphs represent the minimum, average and maximum values of each measurement.

UPS EXTENDED LOG FROM NET VISION MENU ITEM

From this access, the measurements recorded are shown in table mode.
By default, the last 5 records are shown in the table

The time window can also be changed via the calendar

The number of pages available is displayed above and below the table.

UPS Extended Log

from to

Log count per page

<< < 1 2 3 > >>

Start time	End time	Input Voltage (V) R			Input Voltage (V) S			Input Voltage (V) T			*	*	*
dd/mm/yyyy hh:mm:ss	dd/mm/ yyyy hh:mm:ss	Min	Max	Avg	Min	Max	Avg	Min	Max	Avg	*	*	*
											*	*	*

... << < 1 2 3 > >>

Maximum number of records: 2048

If the sample is set to 1 hour, the complete time window is a view of 2048 hours (~85 days and 8 hours)

* Same table for:

- Input Frequency
- Output Voltage
- Output Current
- Output Load Rate
- Battery Capacity
- UPS Temperature

21.3. UPS EVENTS LOG

All incoming and out coming alarms detected by NET VISION are stored in the UPS events log.

UPS Events Log

from to

Log count per page

<< < 1 2 3 > >>

Event Time (dd/mm/yyyy hh:mm:ss) ▼	Event Level ▼	Event Description
01/01/1970 00:00:00	Information Warning Critical	'has been removed' when the alarm disappears

Clicking on ▼ changes the display order: by date and time or by severity level.

List of UPS event stored by NET VISION

UPS Imminent Stop		UPS Power Off	If function present
Overload Alarm		Wrong Configuration	
Ambient Temperature Alarm		Internal / Communication failure	
Transfer locked		Option Board Alarm	
Transfer impossible		External Input 1 to 4 Alarm	If ADC programmed
Insufficient resource	Parallel system only	Unit 1 to 12 General Alarm	Parallel system only
Redundancy lost	Parallel system only	UPS connected	
Output Short circuit detection		UPS not connected	
Maintenance Alarm		Power Plugs 1 to 4 ON	If power share plugs present
Remote Service Alarm	If function present	Power Plugs 1 to 4 OFF	If power share plugs present
General Alarm		Transfer Load to Bypass	UPS STATUS EVENTS
Battery disconnected	If function present	Transfer Load to Inverter	
Battery discharged		Enable eco mode	
End of Backup Time / Battery Low		Disable eco mode	
Operating on Battery		Enable standby mode	
Battery Temperature Alarm	If function present	Disable standby mode	
Battery Room Alarm	If function present	Alarm Acknowledgement	
Battery Test failed		On maintenance bypass	
Battery Alarm		Auto-test in progress	
Rectifier Critical Alarm	Rectifier General Al.	Battery test in progress	
Rectifier Preventive Alarm		Load protected by Inverter	
Rectifier Input Supply not OK		Normal mode	
Gen Set Alarm	If function present	UPS in eco mode	
Charger Critical Alarm		Load on bypass	
Charger Preventive Alarm	Charger General Al.	Unit Available	
Inverter Critical Alarm		On standby	
Inverter Preventive Alarm	Inverter General Al.	Load off	
Bypass Critical Alarm		UPS shut off sent	
Bypass Preventive Alarm	Bypass General Al.	Standby schedule sent	
Bypass Input Supply not OK		Eco mode schedule sent	
Phase Rotation fault			
Maintenance Bypass Alarm			
FAN Failure			

21.4. NET VISION EVENTS LOG

Any modifications of NET VISION configurations and settings are stored in the NET VISION Events log.

NET VISION Events Log

from to

Log count per page

<< < 1 2 3 > >>

Event Time (dd/mm/yyyy hh:mm:ss) ▼	Event Level ▼	Event Description
01/01/1970 00:00:00	Information Warning Critical	

Clicking on ▼ changes the display order: by date and time or by severity level.

List of NET VISION events stored in the log: “???” defines the local IP address

Cold boot
Warm boot
Network link up
Network link down
NET VISION UPS Agent Restart
NET VISION UPS Agent Parameters reset to default
Parameters checksum error
NET VISION UPS Agent Firmware upgrade
History log cleared
Extended history log cleared
UPS event log cleared
NET VISION UPS Agent event log cleared
History log interval changed
Extended history log interval changed
Send shutdown warning to clients
Send shutdown request to clients
Send UPS shutdown command to UPS
Send shutdown cancel to clients
Send UPS output on command to UPS
UPS communication lost
UPS communication restored
??? Time changed by user
??? Time changed by server
??? Time changed by RTC
Cannot connect to mail server
Incorrect Mail receiver
Incorrect Mail server name/IP address
Mail send error/unknown error

Mail sent
Wake On LAN packet sent to clients
All RADIUS servers invalid or connection failed
??? has been changed via ??? by ???
NET VISION UPS Agent event log schema changed. Log has been re-created.
UPS event log schema changed. Log has been re-created.
History log schema changed. Log has been re-created.
Extended history log schema changed. Log has been re-created.
Upload configuration successfully via NET VISION Explorer by ???
Upload configuration with ??? error(s) via NET VISION Explorer by ???
Ntp Time Server Connected Failed
Mail send error:???
Mail send test

If an EMD device is connected and enabled

EMD Temperature not over high Set point
EMD Temperature over high Set point
EMD Temperature not under low Set point
EMD Temperature under low Set point
EMD Humidity not over high Set point
EMD Humidity over high Set point
EMD Humidity not under low Set point
EMD Humidity under low Set point
EMD Alarm-1 not active
EMD Alarm-1 activated
EMD Alarm-2 not active
EMD Alarm-2 activated





21.5. CLEAR & SAVE LOG DATA

This page allows storing all log files to a local computer, to backup files on a local computer or to clear logs on NET VISION.

The log files are stored in CSV format and can be opened with a standard Office programme, such as MS Excel.

Save and Clear log functions are accessible for admin or Read/write account users.

Clear & Save Log Data

 UPS History Log
 UPS Extended Log
 UPS Events Log
 NET VISION Events Log

Clear Log Data		
<input type="radio"/> NET VISION Events Log	<input type="radio"/> UPS Events Log	
<input type="radio"/> UPS Extended Log	<input type="radio"/> UPS History Log	<input type="button" value="Clear"/>

STORED FILES

Click on  to store the file on a local computer

CLEAR LOGS

Select which Log to clear and click on

If the EMD device is connected, the EMD History Log is added as a menu item and added in the logs tables above.

22. APPENDIX

APPENDIX: NET VISION 7 MIB FILE OID DESCRIPTION

upsIdent(1)	No.	Variables
.1.3.6.1.4.1.4555.1.1.7.1.1	1	upsIdentModel
	2	upsIdentSerialNumber
	3	upsIdentUserRef
	4	upsIdentUserLocation
	5	upsIdentAgentSoftwareVersion
	6	upsSystemName
	7	upsSystemContact
	8	upsSystemLocation

upsBattery (2)	No.	Variables	Values
.1.3.6.1.4.1.4555.1.1.7.1.2	1	upsBatteryStatus	unknown(1). batteryNormal(2). batteryCharging(3). batteryTest(4). batteryDischarging(5). batteryLow(6). batteryDepleted(7). batteryFailure(8). batteryDisconnected(9)
	2	upsSecondsOnBattery	Seconds
	3	upsEstimatedMinutesRemaining	Minutes
	4	upsEstimatedChargeRemaining	%
	5	upsBatteryVoltage	Format ###.# V
	6	upsBatteryTemperature	Format ##.# °C (*)
	7	upsAmbientTemperature	Format ##.# °C
	8	upsBatteryCurrent	Format # ###.# A

upsInput(3)	No.	Variables	Values
.1.3.6.1.4.1.4555.1.1.7.1.3	1	upsInputNumLines	3 for 3 phase UPS
	2	upsInputFrequency	Format ##.# Hz
	3	upsInputTable/upsInputEntry/	
	3.1.1	upsInputLineIndex	
	3.1.2	upsInputVoltage	###.# V
	3.1.3	upsInputCurrent	###.# A (*)
	3.1.4	upsInputVoltageMax	###.# V
	3.1.5	upsInputVoltageMin	###.# V



General rule: In case measurements not managed by UPS the related IOD value is set at -1 or 65535.

upsOutput(4)	No.	Variables	Values
.1.3.6.1.4.1.4555.1.1.7.1.4	1	upsOutputSource	Unknown (1). onMaintenanceBypass(2). onInverter(3). normalMode(4). ecoMode(5). onBypass(6). standby(7). upsOff(8). LineInteractive(9).
	2	upsOutputFrequency	Format ##.# Hz
	3	upsOutputNumLines	3 for 3 phase UPS
	4	upsOutputTable/upsOutputEntry/	
	4.1.1	upsOutputLineIndex	
	4.1.2	upsOutputVoltage	###.# V
	4.1.3	upsOutputCurrent	###.# A
	4.1.4	upsOutputPercentLoad	### %
	4.1.5	upsOutputKva	###.# kVA (*)
	4.1.6	upsOutputKw	###.# kW (*)
	5	upsOutputGlobalKva	###.# kVA (*)
	6	upsOutputGlobalKw	###.# kW (*)
	7	upsOutputLoadRate	### %

(*) measurements are set to a value of -1 if the measurement is not managed

upsBypass(5)	No.	Variables	Values
.1.3.6.1.4.1.4555.1.1.7.1.5	1	upsBypassFrequency	Format ##.# Hz
	2	upsBypassNumLines	3 for 3 phase UPS
	3	upsBypassTable/upsBypassEntry/	
	3.1	upsBypassLineIndex	
	3.2	upsBypassVoltage	###.# V
	3.3	upsBypassCurrent	###.# A (*)

upsAlarm(6)	No.	Variables	JBUSP	VU-MAP
	1	upsAlarmsPresent		
	2	upsAlarmTable/upsAlarmEntry/		
	2.1.1	upsAlarmId		
	2.1.2	upsAlarmDescr		
	2.1.3	upsAlarmTime		
	2.1.4	upsAlarmExtDes		
	3	upsWellKnownAlarms/		
	3.1	upsAlarmImminentStop	A31	A000
	3.2	upsAlarmOverload	A02	A001
	3.3	upsAlarmTemperature	A07	A002
	3.4	upsAlarmTransferLock	A45	A003
	3.5	upsAlarmAutoTransferImpossible	A46	A004
	3.6	upsAlarmInsufficientResources	A50	A005
	3.7	upsAlarmRedundancyLost	A43	A006
	3.8	upsAlarmOutputShortCircuit	A09	A007
	3.9	upsAlarmMaintenance	A44	A012
	3.10	upsAlarmRemoteService	A42	A013
	3.11	upsAlarmGeneralFault	A00	A015
	3.12	upsAlarmBatteryCircuitOpen	A59	A016
	3.13	upsAlarmBatteryDischarged	S16 A49	A017
	3.14	upsAlarmLowBattery	S15	A018
	3.15	upsAlarmOnBattery	S05	A019
	3.16	upsAlarmBatteryTemperature	0	A020
	3.17	upsAlarmBatteryRoom	A47	A021
	3.18	upsAlarmBatteryTest	S14	A022
	3.19	upsAlarmBatteryFault	A01	A027
.1.3.6.1.4.1.4555.1.1.7.1.6	3.20	upsAlarmRectifierFault	A52	A032
	3.21	upsAlarmRectifierAlarm	A23	A033
	3.22	upsAlarmReclnputBad	A05	A035
	3.23	upsAlarmGenSetGeneral	A56	A036
	3.24	upsAlarmBatteryChargerFault	A10	A037
	3.25	upsAlarmBatteryChargerAlarm	A26	A038
	3.26	upsAlarmInverterFault	A54	A040
	3.27	upsAlarmInverterAlarm	A25	A041
	3.28	upsAlarmBypassFault	A62	A048
	3.29	upsAlarmBypassAlarm	A29	A049
	3.30	upsAlarmByplnputBad	A06	A050
	3.31	upsAlarmPhaseRotationFault	A61	A051
	3.32	upsAlarmFansFailure	A60	A054
	3.33	upsAlarmMaintenanceBypass	A48	A056
	3.34	upsAlarmUPSPowerOffActive	A58	A059
	3.35	upsAlarmWrongConfiguration	A20	A060
	3.36	upsAlarmInternalFailure	A19	A061
	3.37	upsAlarmOptionalBoards	A51	A062
	3.38	upsAlarmExternalAlarm1	A38	A064
	3.39	upsAlarmExternalAlarm2	A39	A065
	3.40	upsAlarmExternalAlarm3	A40	A066
	3.41	upsAlarmExternalAlarm4	A41	A067
	3.42	upsAlarmModule1Alarm	A32	A096
	3.43	upsAlarmModule2Alarm	A33	A097
	3.44	upsAlarmModule3Alarm	A34	A098
	3.45	upsAlarmModule4Alarm	A35	A099

.1.3.6.1.4.1.4555.1.1.7.1.6	3.46	upsAlarmModule5Alarm	A36	A100
	3.47	upsAlarmModule6Alarm	A37	A101
	3.48	upsAlarmModule7Alarm	0	A102
	3.49	upsAlarmModule8Alarm	0	A103
	3.50	upsAlarmModule9Alarm	0	A104
	3.51	upsAlarmModule10Alarm	0	A105
	3.52	upsAlarmModule11Alarm	0	A106
	3.53	upsAlarmModule12Alarm	0	A107
	3.54	upsAlarmAutoTestRunning	0	S030
	3.55	upsAlarmOnBypass	S04&!S07	S002&!S007
	3.56	upsAlarmUpsOutputOff	!S03&!S04	S004
	3.57	upsAlarmUpsSystemOff	!S02&!S01&S04	
	3.58	upsAlarmCommunicationLost		
	3.59	upsAlarmShutdownPending		
	3.60	upsAlarmShutdownRequested		
	3.61	upsAlarmShutdownImminent		
	3.62	upsAlarmAwaitingPower		

upsControl(7)	No.	Variables	Values
.1.3.6.1.4.1.4555.1.1.7.1.7	1	upsControlStatusControl*	upsStandbyOn (1).
			upsStandbyOff (2).
			upsEcoMode (3).
			upsNormalMode (4).
			upsAlarmReset (5).
			upsOnBypass (6).
			upsOnInverter (7)
	2	upsShutdownDelay	
	3	upsTurnOffAfterShutdown	
	4	upsControlShutdownParametersTable	
	4.1.1	upsControlEventDescr	
	4.1.2	upsControlEventStatus	
	4.1.3	upsControlDelay	
	4.1.4	upsControlFirstWarning	
	4.1.5	upsControlWarningInterval	
	5	upsControlWeeklyScheduleTable	
	5.1.1	upsControlWeeklyIndex	
	5.1.2	upsControlWeeklyShutdownDay	
	5.1.3	upsControlWeeklyShutdownTime	
	5.1.4	upsControlWeeklyRestartDay	
	5.1.5	upsControlWeeklyRestartTime	
	6	upsControlSpecialScheduleEntry	
	6.1.1	upsControlSpecialIndex	
	6.1.2	upsControlSpecialShutdownDay	
	6.1.3	upsControlSpecialShutdownTime	
	6.1.4	upsControlSpecialRestartDay	
	6.1.5	upsControlSpecialRestartTime	
	7	upsControlEcoModeScheduleTable	
	7.1.1	upsControlEcoModeIndex	
	7.1.2	upsControlEcoModeStartDay	
	7.1.3	upsControlEcoModeStartTime	
7.1.4	upsControlEcoModeEndDay		
7.1.5	upsControlEcoModeEndTime		

* Control executed only if remote control enabled

upsConfig(8)	No.	Variables
.1.3.6.1.4.1.4555.1.1.7.1.8	1	upsConfigNomKva
	2	upsConfigNbrUnit
	3	upsConfigUnitKva
	4	upsConfigRemoteCtrl
	5	upsDevicesTable/upsDevicesEntry
	5.1.1	indexOfDevice
	5.1.2	addrOfDevice
	5.1.3	nameOfDevice
	5.1.4	timeOfConnection
	5.1.5	statusOfConnection
	5.1.6	severityOfConnection

upsAgent(9)	No.	Variables
.1.3.6.1.4.1.4555.1.1.7.1.9	1	upsAgentIpaddress
	2	upsAgentGateway
	3	upsAgentSubnetMask
	4	upsAgentDate
	5	upsAgentTime
	6	upsAgentNtpTimeServer
	7	upsAgentNtpTimeZone
	8	upsAgentHistoryLogFrequency
	9	upsAgentExtHistoryLogFrequency
	10	upsAgentPollRate
	11	upsAgentBaudRate
	12	upsAgentDhcpStatus
	13	upsAgentTelnetStatus
	14	upsAgentTftpStatus
	15	upsAgentResetToDefault
	16	upsAgentRestart
	17	upsAgentClearAgentLog
	18	upsAgentClearEventLog
	19	upsAgentClearExtHistoryLog
	20	upsAgentClearHistoryLog
	21	upsAgentTrapsReceiversTable/upsAgentTrapsReceiversEntry
	21.1.1	trapsIndex
	21.1.2	trapsReceiverAddr
21.1.3	receiverCommunityString	
21.1.4	receiverNmstype	
22	upsAgentAccessControlTable/upsAgentAccessControlEntry	
23	upsAgentMibVersion	
50	upsAgentTrapString	

emdStatus(10)	No.	Variables
.1.3.6.1.4.1.4555.1.1.7.1.10	1	emdStatusTemperature
	2	emdStatusHumidity
	3	emdStatusIn1Active
	4	emdStatusIn2Active

APPENDIX: NET VISION 7 TRAP DESCRIPTION

upsTraps(2)	No.	Variables	Level	JBUSP	VU-MAP
Sent if TRAP Filter enabled	1	upsTrapOnBattery	Critical	S05	A019 & S000
	2	upsTrapTestCompleted	Not managed		
	3	upsTrapAlarmEntryAdded	Warning	upsWellKnownAlarms OID	
	4	upsTrapAlarmEntryRemoved	Information	upsWellKnownAlarms OID	
TRAP send to Remote View Pro monitoring SW	5	upsTrapImminentStop	Critical	A31	A000
	6	upsTrapOverload	Warning	A02	A001
	7	upsTrapRedundancyLost	Warning	A43	A006
	8	upsTrapBatteryCircuitOpen	Critical	A59	A016
	9	upsTrapBatteryDischarged	Critical	S16	A017
	10	upsTrapBatteryLow	Critical	S15	A018
	11	upsTrapBatteryAlarm	Warning	A01	A027
	12	upsTrapUpsCriticalAlarm	Critical	A52 A54 A62	A032 A040 A048
	13	upsTrapLoadOFF	Critical	!S03&!S04	S004
	14	upsTrapCommunicationLost	Critical	NET VISION event	
	15	upsTrapOnBatteryPower	Warning	S05	A019 & S000
	16	upsTrapBatteryTestfailed	Warning	S14	A022
	17	upsTrapTemperatureAlarm	Warning	A07	A020
	18	upsTrapOnBypass	Warning	S04&!S06	S002
	19	upsTrapUpsPreventiveAlarm	Warning	A00	A015
	20	upsTrapShutdownWarning	Warning	Shutdown agent	
	21	upsTrapShutdownrequest	Warning		
	22	upsTrapUpsNormal	Information	S03	S000 S001
	23	upsTrapPowerRestored	Information	S00	S048
	24	upsTrapAlarmCancelled	Information	!A15	!A015
	25	upsTrapComEstablished	Information	Shutdown agent	
	26	upsTrapShutdwonCancelled	Information		
	27	upsTrapAgentRestarting	Information	NET VISION event	
	28	upsTrapEmdTempLow	Critical	EMD events	
	29	upsTrapEmdTempNotLow	Information		
	30	upsTrapEmdTempHigh	Critical		
	31	upsTrapEmdTempNotHigh	Information		
	32	upsTrapEmdHumidityLow	Critical		
	33	upsTrapEmdHumidityNotLow	Information		
	34	upsTrapEmdHumidityHigh	Critical		
	35	upsTrapEmdHumidityNotHigh	Information		
	36	upsTrapEmdFirstInputActive	Critical		
	37	upsTrapEmdFirstInputRestored	Information		
	38	upsTrapEmdSecondInputActive	Critical		
	39	upsTrapEmdSecondInputRestored	Information		
	40	TRAP TEST	Information		Manual test

TRAP1 to TRAP4 are managed as defined by RFC1628.

TRAP1: sent every minute with remaining backup time and running time on battery as parameters.

TRAP3: sent every time a new alarm is added to the list.

The alarm index sent as parameters follows the well-known alarm index OID.

TRAP4: sent every time when an alarm is removed from alarm list. The alarm index is the same as sent with TRAP3.

APPENDIX: RFC1628 WELLKNOWALARMS OID DESCRIPTION

Those alarms OID and description are reported in TRAP 3 (added) and TRAP 4 (removed)

OID	.1.3.6.1.2.1.33.1.6.3	JBUSP	VU-MAP	
.1	upsAlarmBatteryBad	A01 or A47	A027 or A20 or A21	
.2	upsAlarmOnBattery	S05	A019 & S000	
.3	upsAlarmLowBattery	S15	A018	
.4	upsAlarmDepletedBattery	S16 A49	A017	
.5	upsAlarmTempBad	A07	A002	
.6	upsAlarmInputBad	A05	A035	
.7	upsAlarmOutputBad			Not available
.8	upsAlarmOutputOverload	A02	A001	
.9	upsAlarmOnBypass	S04&!S07	S002&!S006	
.10	upsAlarmBypassBad	A29	A049	Critical alarm
.11	upsAlarmOutputOffAsRequested			Not available
.12	upsAlarmUpsOffAsRequested			Not available
.13	upsAlarmChargerFailed	A26	A038	
.14	upsAlarmUpsOutputOff	!S03&!S04	S004	
.15	upsAlarmUpsSystemOff	!S02 & !S03 & !S04	!S049 & !S52 & !S57	
.16	upsAlarmFanFailure	A60	A054	
.17	upsAlarmFuseFailure			Not available
.18	upsAlarmGeneralFault	A00	A015	
.19	upsAlarmDiagnosticTestFailed	S14	A022	Battery test failed
.20	upsAlarmCommunicationsLost			NV alarm
.21	upsAlarmAwaitingPower			Shutdown agent
.22	upsAlarmShutdownPending			Shutdown agent
.23	upsAlarmShutdownImminent			Shutdown agent
.24	upsAlarmTestInProgress	S10	A034	Battery test

APPENDIX: MODBUS TCP ACCESS

MODBUS TCP PROTOCOL

NET VISION follows IDA frame format.

MODBUS write functions 0x06 and 0x10 are not allowed.

FOR JBUSP UPS (NETYS / ITYS / MODULYS / MASTERYS MC – BC – GP – IP+ / DELPHYS MP – MX – BC – GP – XTEND)

Data	Address	Words	Access	Type	Acronym
STATUS	0x1020	4	READ	bit	S00-S63
ALARMS	0x1040	4	READ	bit	A00-A63
MEASUREMENTS	0x1060	48	READ	word	M00-M47
IDENTIFIERS	0x1000	12	READ	Values / ASCII	I00_I11
CONFIGURATION	0x10E0	16	READ	Values	T00-T15

Please refer to Appendix JBUSP UPS MODBUS TABLE

FOR VU-MAP UPS (MASTERYS BC+/GP4 / MODULYS XS - GP 2.0 - XL / DELPHYS BC - GP - XTEND with touchscreen panel)

Data	Address	Words	Access	Type	Acronym
STATUS	0x0030	6+2(*)	READ	bit	S000-S127
ALARMS	0x0038	6+2(*)	READ	bit	A000-A127
MEASUREMENTS	0x0040	80	READ	word	M000 – M079
CONFIGURATIONS	0x0001	15	READ	word	T001 – T015
SERIAL NUMBER	0x0010	10	READ	ASCII	R000
UPS REFERENCE	0x001A	10	READ	ASCII	R001

(*) 2 additional words for units status and alarms synthesis for parallel systems UPS

Please refer to Appendix VU-MAP UPS MODBUS TABLE

NET VISION allows reading part of the table or single word.

APPENDIX: VU-MAP MODBUS TABLE

List of status managed by the UPS. This table is accessible on MODBUS TCP by requesting 8 words to address 0x0030.

Reading the 4 first words of status table are enough to monitor single UPS, as the next words are linked to parallel system data.

Address	level	Acronym	Description	Address	level	Acronym	Description
0x0030	I	S000	Load protected by Inverter	0x0034		S064	Card in Slot 1 present
		S001				S065	Card in Slot 2 present
	W	S002	Load supplied by automatic Bypass			S066	Card in Slot 3 present
	W	S003	Load supplied by Maintenance Bypass			S067	Card in Slot 4 present
	C	S004	Load OFF			S068	Card in Slot 5 present
		S005				S069	Card in Slot 6 present
	I	S006	UPS in eco mode			S070	
	I	S007	UPS in energy saver			S071	
		S008	Heat Run test			S072	Programmable S072
	W	S009	In Service mode			S073	Programmable S073
		S010	Line-interactive mode			S074	Programmable S074
	I	S011	Operating			S075	Programmable S075
	I	S012	Available			S076	Programmable S076
	W	S013	on Standby			S077	Programmable S077
	I	S014	Unit isolated			S078	Programmable S078
W	S015	Maintenance Alert		S079	Programmable S079		
0x0031		S016	Output Breaker closed	0x0035		S080	Module Insertion Procedure
		S017	Maintenance Bypass closed			S081	Module Extraction Procedure
		S018	External Maintenance Bypass closed			S082	UPS in line interactive operation
		S019	External Output Breaker closed			S083	Battery circuit open
		S020	Single phase Input supply			S084	Backfeed protection open
		S021	Rectifier Input Breaker			S085	Bypass Locked
		S022	Bypass Input Breaker			S086	Adv GEN SET Static mode – Soft Load
	I	S023	Gen set ON			S087	Derating charge for LIB
		S024	Busbar 1 closed			S088	FREE
		S025	Busbar 2 closed			S089	
	I	S026	Automatic Start in progress			S090	
	W	S027	Maintenance Bypass proc. in progress			S091	
	W	S028	UPS OFF procedure in progress			S092	
		S029				S093	
	I	S030	Auto-test Procedure in progress			S094	
	I	S031	Alarm Acknowledgement requested			S095	

Address	level	Acronym	Description	Address	level	Acronym	Description
0x0032	I	S032	Battery OK	0x0036		S096	[1] is operating
	I	S033	Battery charged			S097	[2] is operating
	I	S034	Battery Test in progress			S098	[3] is operating
	I	S035	Battery Test programmed			S099	[4] is operating
	I	S036	Battery charging			S100	[5] is operating
	W	S037	Battery Test interrupted			S101	[6] is operating
	I	S038	Floating Voltage reduced			S102	[7] is operating
	I	S039	Battery discharge to Input			S103	[8] is operating
	I	S040	UPS backup system connected			S104	[9] is operating
	I	S041	UPS backup system charged / ready			S105	[10] is operating
	I	S042	UPS backup system charging			S106	[11] is operating
		S043				S107	[12] is operating
		S044				S108	[13] is operating
		S045				S109	[14] is operating
	S046			S110	[15] is operating		
	S047			S111			
0x0033	I	S048	Rectifier Input Supply present	0x0037		S112	[1] is available
	I	S049	Rectifier ON			S113	[2] is available
	I	S050	Charger ON			S114	[3] is available
		S051	Rectifier is starting			S115	[4] is available
	I	S052	Inverter ON			S116	[5] is available
	I	S053	Inverter Switch ON			S117	[6] is available
		S054				S118	[7] is available
		S055	Bypass output breaker closed			S119	[8] is available
	I	S056	Bypass Input Supply present			S120	[9] is available
	I	S057	Bypass Static Switch closed			S121	[10] is available
	I	S058	Bypass Input & Inverter synchronised			S122	[11] is available
	I	S059	ACS external synchronisation			S123	[12] is available
		S060	PowerShare Plug 1 closed			S124	[13] is available
		S061	PowerShare Plug 2 closed			S125	[14] is available
	S062	PowerShare Plug 3 closed		S126	[15] is available		
	S063	PowerShare Plug 4 closed		S127	Data no longer updated		

List of alarms managed by the UPS. This table is accessible on MODBUS TCP by requesting 8 words to address 0x0038.

Reading the 4 first words of alarms table are enough to monitor single UPS, as the next words are linked to parallel system data.

Address	level	Acronym	Description	Address	level	Acronym	Description
0x0038	C	A000	Imminent Stop	0x003C		A064	Programmable A064
	W	A001	Overload Alarm			A065	Programmable A065
	W	A002	Ambient Temperature Alarm			A066	Programmable A066
	W	A003	Transfer locked			A067	Programmable A067
	W	A004	Transfer impossible			A068	Programmable A068
	W	A005	Insufficient Resources			A069	Programmable A069
	W	A006	Redundancy lost			A070	Programmable A070
	W	A007	Output short circuit detection			A071	Programmable A071
		A008	eco mode disabled by UPS			A072	Line-Interactive mode disabled by UPS
		A009	energy saver disabled by UPS			A073	Features using batteries unavailable
		A010	On Bypass for 1 hour			A074	FREE
		A011	Bypass output breaker closed			A075	
	W	A012	Maintenance Alarm			A076	
	W	A013	Remote Service Alarm			A077	
		A014	Remote Service Preventive Alarm			A078	
W	A015	General Alarm		A079			
0x0039	C	A016	Battery disconnected	0x003D		A080	Customer Installation Overload
	C	A017	Battery discharged			A081	FREE
	W	A018	End of Backup Time			A082	
	W	A019	Operating on Battery			A083	
	W	A020	Battery Temperature Alarm			A084	
	W	A021	Battery Room Alarm			A085	
	W	A022	Battery Test failed			A086	
		A023	BMS has detected a weak String			A087	
		A024	At least one Battery String open			A088	
		A025	On Battery with Mains OK			A089	
		A026	Insulation fault			A090	
	W	A027	Battery Alarm			A091	
		A028	Battery preventive alarm*			A092	
		A029	UPS Backup Critical Alarm			A093	
		A030	UPS Backup preventive alarm			A094	
		A031	UPS Backup not OK			A095	

* available only if the function is managed by the UPS

Address	level	Acronym	Description	Address	level	Acronym	Description
0x003A	C	A032	Rectifier Critical Alarm	0x003E	W	A096	[1] in general Alarm
	W	A033	Rectifier Preventive Alarm		W	A097	[2] in General Alarm
		A034	Rectifier Redundancy Alarm		W	A098	[3] in General Alarm
		A035	Rectifier Input Supply not OK		W	A099	[4] in General Alarm
	W	A036	Gen Set Alarm		W	A100	[5] in General Alarm
	C	A037	Charger Critical Alarm		W	A101	[6] in General Alarm
	W	A038	Charger Preventive Alarm		W	A102	[7] in General Alarm
		A039	Battery charge interrupted		W	A103	[8] in General Alarm
	C	A040	Inverter Critical Alarm		W	A104	[9] in General Alarm
	W	A041	Inverter Preventive Alarm		W	A105	[10] in General Alarm
		A042	Inverter Redundancy Alarm		W	A106	[11] in General Alarm
		A043	Redundancy Imminent Lost		W	A107	[12] in General Alarm
		A044	Consumable Alarm			A108	[13] in General Alarm
		A045	Unit Redondancy lost			A109	[14] in General Alarm
		A046	Parallel board Critical Alarm			A110	[15] in General Alarm
	A047	Parallel board Preventive Alarm		A111			
0x003B	C	A048	Bypass Critical Alarm	0x003F	C	A112	[1] in Imminent STOP
	W	A049	Bypass Preventive Alarm		C	A113	[2] in Imminent STOP
	W	A050	Bypass Input Supply not OK		C	A114	[3] in Imminent STOP
	W	A051	Phase Rotation fault		C	A115	[4] in Imminent STOP
		A052	Bypass Back-feed detection		C	A116	[5] in Imminent STOP
		A053	Transformer Alarm		C	A117	[6] in Imminent STOP
	W	A054	FAN Failure		C	A118	[7] in Imminent STOP
		A055	ACS Alarm		C	A119	[8] in Imminent STOP
	W	A056	Maintenance Bypass Alarm		C	A120	[9] in Imminent STOP
		A057	Internal Back-feed detection		C	A121	[10] in Imminent STOP
		A058	Battery monitoring Alarm		C	A122	[11] in Imminent STOP
	C	A059	UPS Power OFF		C	A123	[12] in Imminent STOP
	W	A060	Wrong Configuration			A124	[13] in Imminent STOP
	W	A061	Internal / Communication failure			A125	[14] in Imminent STOP
	W	A062	Option Board Alarm			A126	[15] in Imminent STOP
	A063	Spare part not		A127			

Alarms without a level indication are not managed by NET VISION.

List of measurements managed by the UPS.

This table is accessible on MODBUS TCP by requesting up to 80 words to address 0x0040.

Address	Acronym	Description	Unit	0x000E=0	0x000E=1
0x0040	M000	Output load rate	%	###	###
0x0041	M001	Output load rate L1	%	###	###
0x0042	M002	Output load rate L2	%	###	###
0x0043	M003	Output load rate L3	%	###	###
0x0044	M004	Output Apparent Power	kVA	## ###	# ###.#
0x0045	M005	Output Active Power	kW	## ###	# ###.#
0x0046	M006	Output current L1	A	## ###	# ###.#
0x0047	M007	Output current L2	A	## ###	# ###.#
0x0048	M008	Output current L3	A	## ###	# ###.#
0x0049	M009	Output neutral current	A	## ###	# ###.#
0x004A	M010	Output voltage L1	V	###	###
0x004B	M011	Output voltage L2	V	###	###
0x004C	M012	Output voltage L3	V	###	###
0x004D	M013	Output frequency	Hz	##.#	##.#
0x004E	M014	Output Crest Factor		##.#	##.#
0x004F	M015	Ambient Temperature	°C	##.#	##.#
0x0050	M016	Battery voltage string +	V	# ###	###.#
0x0051	M017	Battery voltage string -	V	# ###	###.#
0x0052	M018	Battery current string +	A	## ###	# ###.#
0x0053	M019	Battery current string -	A	## ###	# ###.#
0x0054	M020				
0x0055	M021				
0x0056	M022	Battery capacity	%	###	###
0x0057	M023	Battery capacity	Ah	## ###	# ###.#
0x0058	M024	Remaining Battery backup time	Mn	###	###
0x0059	M025	Time on battery	s	###	###
0x005A	M026	Battery temperature	°C	##.#	##.#
0x005B	M027	Battery temperature average	°C	##.#	##.#
0x005C	M028	DC Storage voltage	V	# ###	###.#
0x005D	M029	DC Storage temperature	°C	##.#	##.#
0x005E	M030				
0x005F	M031				
0x0060	M032	Rect. input supply volt. L1	V	###	###
0x0061	M033	Rect. input supply volt. L2	V	###	###
0x0062	M034	Rect. input supply volt. L3	V	###	###
0x0063	M035	Rect. input supply freq.	Hz	##.#	##.#
0x0064	M036	Rect. input supply volt. U12	V	###	###
0x0065	M037	Rect. input supply volt. U23	V	###	###
0x0066	M038	Rect. input supply volt. U31	V	###	###
0x0067	M039	Bypass input supply voltage L1	V	###	###
0x0068	M040	Bypass input supply voltage L2	V	###	###
0x0069	M041	Bypass input supply voltage L3	V	###	###

Address	Acronym	Description	Unit	0x000E=0	0x000E=1
0x006A	M042	Bypass input supply freq.	Hz	##.#	##.#
0x006B	M043	Bypass input supply volt U12	V	###	###
0x006C	M044	Bypass input supply volt. U23	V	###	###
0x006D	M045	Bypass input supply volt. U31	V	###	###
0x006E	M046				
0x006F	M047				
0x0070	M048	Output Apparent P. L1	kVA	## ###	# ###.#
0x0071	M049	Output Apparent P. L2	kVA	## ###	# ###.#
0x0072	M050	Output Apparent P. L3	kVA	## ###	# ###.#
0x0073	M051	Output Active Power L1	kW	## ###	# ###.#
0x0074	M052	Output Active Power L2	kW	## ###	# ###.#
0x0075	M053	Output Active Power L3	kW	## ###	# ###.#
0x0076	M054	Output voltage U12	V	###	###
0x0077	M055	Output voltage U23	V	###	###
0x0078	M056	Output voltage U31	V	###	###
0x0079	M057	Output Power factor L1		#.##	#.##
0x007A	M058	Output Power factor L2		#.##	#.##
0x007B	M059	Output Power factor L3		#.##	#.##
0x007C	M060	Output Crest Factor L1		#. #	#. #
0x007D	M061	Output Crest Factor L2		#. #	#. #
0x007E	M062	Output Crest Factor L3		#. #	#. #
0x007F	M063	Output Crest Factor neutral		#. #	#. #
0x0080	M064	Rect. Input Current L1	A	## ###	# ###.#
0x0081	M065	Rect. Input Current L1	A	## ###	# ###.#
0x0082	M066	Rect. Input Current L1	A	## ###	# ###.#
0x0083	M067	Rect. Active Power L1	kW	## ###	# ###.#
0x0084	M068	Rect. Active Power L2	kW	## ###	# ###.#
0x0085	M069	Rect. Active Power L3	kW	## ###	# ###.#
0x0086	M070	Bypass Input Current L1	A	## ###	# ###.#
0x0087	M071	Bypass Input Current L2	A	## ###	# ###.#
0x0088	M072	Bypass Input Current L3	A	## ###	# ###.#
0x0089	M073	Bypass Active Power L1	kW	## ###	# ###.#
0x008A	M074	Bypass Active Power L2	kW	## ###	# ###.#
0x008B	M075	Bypass Active Power L3	kW	## ###	# ###.#
0x008C	M076				
0x008D	M077				
0x008E	M078				
0x008F	M079				

List of UPS configurations .

This table is accessible on MODBUS TCP by requesting up to 15 words to address 0x0001.

Ad- dress	Acro- nym	Description	Value		Remarks
			MSB	LSB	
0x0001	T001	UPS installation code and Device type	UPS installation Code	Device type	01:01 = single unit 08:01 or 09:01 = modular unit 06:01 = distributed bypass UPS parallel system 06:08 = modular parallel UPS system
0x0002	T002	Number of devices in level -1	1 to 15		1 to 8 modules/units
0x0003	T003	Position of devices present	b00	module/unit 1 present	
			b01	module/unit 2 present	
			b02	module/unit 3 present	
			b03	module/unit 4 present	
			b04	module/unit 5 present	
			b05	module/unit 6 present	
			b06	module/unit 7 present	
			b07	module/unit 8 present	
			b08		
			b09		
			b10		
			b11		
			b12		
			b13	bypass module	
			b14		
b15					
0x0004	T004	Device number	1 to 15		1 to 8
0x0005	T005	Nominal kVA	*10 if 0x000E = 1		depends number of modules
0x0006	T006	Nominal kW	*10 if 0x000E = 1		depends number of modules
0x0007	T007	Phases number	Input phases 1 - 3	Output phases 1 - 3	
0x0008	T008	Function	b00	eco mode enabled	
			b01	energy saver enabled	
			b02		
			b03	genset present	
			b04		
			b05		
			b06	Standby schedule	
			b07		
			b08		
			b09	backfeed present	
			b10		
			b11		
			b12		
			b13		
			b14		
b15					

Ad- dress	Acro- nym	Description	Value		Remarks
			MSB	LSB	
0x0009	T009	Environment	b00	External transformer	
			b01	External input breaker	
			b02	External output breaker	
			b03	Double-bus bar	
			b04	External bypass	
			b05	Super bypass	
			b06	Without bypass	
			b07	Without maintenance bypass	
			b08		
			b09		
			b10		
			b11		
			b12		
			b13		
			b14		
b15					
0x000A	T010	DC storage	b00	battery present	
0x000B	T011				
0x000C	T012				
0x000D	T013				
0x000E	T014	measurements factor	0 = no factor / 1 = factor * 10		
0x000F	T015	Device reference code			0x8001 = ITYS PRO 0x8100 = MODULYS GP 2.0 0x8110 = MODULYS RM GP 0x8140 = MODULYS XM 0x8180 = MODULYS XS 0x81A0 = MODULYS XL 0x8200 = MASTERYS BC+ 0x8300 = MASTERYS GP4 0x8400 = DELPHYS XL 0x0288 = DELPHYS BC - GP 2.0

APPENDIX: JBUSP UPS MODBUS TABLE

List of status managed by UPS. This table is accessible on MODBUS TCP by requesting 4 words to address 0x1020.

	Level		NETYS PR/RT ITYS	MASTERYS BC/GP	DELPHYS MP/MX	DELPHYS BC/GP
S00	I	Rectifier Input supply present	X	X	X	X
S01	I	Inverter ON	X	X	X	X
S02	I	Rectifier ON	X	X	X	X
S03	I	Load protected by inverter	X	X	X	X
S04	W	Load on automatic bypass	X	X	X	X
S05	W	on battery / Battery discharging	X	X	X	X
S06		Remote controls disabled		X	X	X
S07		Eco-mode ON	X	X	X	X
S08	W	Stand-by mode	X	X		
S09		Buzzer on	X	X	X	X
S10	I	Battery test in progress	X	X	X	X
S11	I	Battery test programmed		X	X	X
S12	I	Battery test in stand-by		X	X	X
S13	I	Battery test supported	X	X	X	X
S14	W	Battery test failed	X	X	X	X
S15	C	Battery near end of backup time	X	X	X	X
S16	C	Battery discharged	X	X	X	X
S17	I	Battery OK	X	X	X	X
S18						
S19						
S20						
S21						
S22						
S23		Inverter synchro with mains	X	X	X	X
S24		Boost on	X	X		
S25						
S26	I	Bypass input supply present	X	X	X	X
S27	I	Battery charging	X	X	X	X
S28		Bypass input fr. out of tolerance	X	X	X	X
S29		Stand-by schedule				
S30		UPS on parallel system		For parallel	For parallel	For parallel
S31		Battery extension		X		
S32		Unit 1 present		If parallel system ac- cording to number of units	If parallel sys- tem according to number of units	If parallel sys- tem accord- ing to number of units
S33		Unit 2 present				
S34		Unit 3 present				
S35		Unit 4 present				
S36		Unit 5 present				
S37		Unit 6 present				
S38		External Input 1		X	X	X
S39		External Input 2		X	X	X
S40		External Input 3		X	X	X
S41		External Input 4		X	X	X
S42		Controls permission table managed	X	X	X	X
S43		power share	If present			
S44						
S45						
S46	I	Operating on Gen Set		If present	If present	If present
S47						
S48	W	Maintenance mode active		X	X	X
S49	W	End of the first maintenance period		X	X	X
...						
S63						

For more information please refer to MODBUS User manual according to the UPS range.

List of alarms managed by the UPS. This table is accessible on MODBUS TCP by requesting 4 words to address 0x1040.

	Level		NETYS/ITYS	MASTERYS BC/GP	DELPHYS MP/MX	DELPHYS GP
A00	W	General Alarm	X	X	X	X
A01	W	Battery failure	X	X	X	X
A02	W	UPS overload	X	X	X	X
A03		Output voltage out of tolerance	X			
A04		Control failure	X	X		
A05	W	Rec. input supply out of tolerance	X		X	X
A06	W	Bypass input supply out of tolerance	X	X	X	X
A07	W	Over temperature alarm	X	X	X	X
A08	W	Maintenance bypass closed		X	X	X
A09						
A10	W	Battery charger fault		X	X	
A11						
A12						
A13		Pre-charge out of tolerance		X		
A14		BOOST too low		X		
A15		BOOST too high		X		
A16		VDC too high		X		X
A17		Improper condition of use			X	X
A18		Inverter stopped for overload	X	X	X	
A19	W	Microprocessor control system			X	
A20	W	data map corrupted		X		
A21		PLL fault (sources synchronization)		X	X	
A22		Rectifier input supply fault	X	X	X	X
A23	W	Rectifier preventive alarm		X	X	X
A24						
A25	W	Inverter preventive alarm		X	X	X
A26	W	Charger general alarm		X	X	X
A27		Output Voltage over limit		X		
A28						
A29	W	Bypass preventive alarm			X	X
A30		UPS stopped for overload	X	X		
A31	C	Imminent STOP	X	X	X	X
A32	W	Unit 1 general alarm		If parallel system according to number of units	If parallel system according to number of units	If parallel system according to number of units
A33	W	Unit 2 general alarm				
A34	W	Unit 3 general alarm				
A35	W	Unit 4 general alarm				
A36	W	Unit 5 general alarm				
A37	W	Unit 6 general alarm				
A38	W	External alarm 1		X	X	X
A39		External alarm 2		X		
A40		External alarm 3		X		
A41		External alarm 4		X		
A42	W	Remote service alarm		X	X	X

	Level		NETYS/ITYS	MASTERYS BC/GP	DELPHYS MP/ MX	DELPHYS GP
A43	W	redundancy loss			X	X
A44	W	Servicing alarm		X	X	X
A45	W	Auto. and manual transfer disable			X	X
A46	W	Automatic transfer disable			X	X
A47	W	Battery room alarm			X	X
A48	W	Maintenance bypass alarm			X	X
A49	C	Battery discharged		X	X	X
A50	W	insufficient resources		X	X	X
A51	W	Synoptic alarm		X	X	X
A52	C	Rectifier fault		X	X	X
A53						
A54	C	Inverter fault		X	X	X
A55		Parallel fault		X		
A56	W	Gen set alarm		If option set		
A57		Gen set fault		If option set		
A58	C	ESD activated		X	X	X
A59	C	Battery circuit open		X	X	X
A60	W	Fan failure		X		
A61	W	Phase rotation fault		X		
A62	C	Bypass critical alarm			X	X
A63						

Alarms without a level indication are not managed by NET VISION.

For more information please refer to the MODBUS User manual according to the UPS range.

List of measurements managed by UPS. This table is accessible on MODBUS TCP by requesting 48 words to address 0x1060.

Address	Code	Description	Units	Format	NETYS/ ITYS	MASTERYS	DELPHYS MP/MX	DELPHYS BC/GP
0x1060	M00	Load rate phase1	%	###	X	X	X	X
0x1061	M01	Load rate phase 2	%			X	X	X
0x1062	M02	Load rate phase 3	%			X	X	X
0x1063	M03	UPS load rate	%	###	X	X	X	X
0x1064	M04	Battery Capacity	%	###	X	X	X	X
0x1065	M05	Battery Capacity	Ah*10	###.#		X	X	X
0x1066	M06	Input bypass voltage phase 1	V	###	X	X	X	X
0x1067	M07	Input bypass voltage phase 2	V			X	X	X
0x1068	M08	Input bypass voltage phase 3	V			X	X	X
0x1069	M09	Output voltage phase 1	V	###	X	X	X	X
0x106A	M10	Output voltage phase 2	V			X	X	X
0x106B	M11	Output voltage phase 3	V			X	X	X
0x106C	M12	Input current L1	A			X	-1	-1
0x106D	M13	Input current L2	A			X	-1	-1
0x106E	M14	Input current L3	A			X	-1	-1
0x106F	M15	Output current phase 1	A*10	###.#	X	X	X	X
0x1070	M16	Output current phase 2	A*10			X	X	X
0x1071	M17	Output current phase 3	A*10			X	X	X
0x1072	M18	Input bypass frequency	Hz*10	##.#	X	X	X	X
0x1073	M19	Output frequency	Hz*10	##.#	X	X	X	X
0x1074	M20	Battery voltage (+)	V*10	###.#	X	X	X	X
0x1075	M21	Battery voltage (-)	V*10	###.#	-1	X	-1	-1
0x1076	M22	Ambient Temperature	°C	##	X	X	X	X
0x1077	M23	Remaining backup time	Minutes	####	X	X	X	X
0x1078	M24	Battery current	A*10	±###.#	-1	X	X	X
0x1079	M25							
0x107A	M26							
0x107B	M27							
0x107C	M28							
0x107D	M29							
0x107E	M30							
0x107F	M31							
0x1080	M32							
0x1081	M33	Rectifier input voltage phase 1	V	###	X	X	X	X
0x1082	M34	Rectifier input voltage phase 2	V			X	X	X
0x1083	M35	Rectifier input voltage phase 3	V			X	X	X
0x1084	M36	UPS output power	kW*10			X	X	-1
0x1085	M37	Output power phase 1	kVA*10	###.#		X	X	X
0x1086	M38	Output power phase 2	kVA*10			X	X	X
0x1087	M39	Output power phase 3	kVA*10			X	X	X
0x1088	M40	Input power L1				X	X	X

Address	Code	Description	Units	Format	NETYS/ ITYS	MASTERYS	DELPHYS MP/MX	DELPHYS BC/GP
0x1089	M41	Input power L2				X	X	X
0x108A	M42	Input power L3				X	X	X
0x108B	M43	Rec input Fr	Hz*10	##.##		X	-1	-1
0x108C	M44							
0x108D	M45							
0x108E	M46							
0x108F	M47							

Value -1 means that the measurement is not managed by the UPS. and not displayed by NET VISION.

List of UPS configurations .

This table is accessible on MODBUS TCP by requesting up to 15 words to address 0x10E0 and 12 words to address 0x1000.

Address	Acronym	Description	Value		Remarks
			MSB	LSB	
0x1000	T00	UPS TYPE	see list		
0x1001	T01	Nomnival kVA *10	* 10		
0x1002	T02	Module number	1		
0x1003	T03	Serail number	char 2	char 1	ASCII format
0x1004	T04				
0x1005	T05				
0x1006	T06				
0x1007	T07		char 10	char 9	
0x1008	T08	Not used			
0x1009	T09				
0x100A	T10				
0x100B	T11				

Adress	Code	Description	Unit	Format
0x10E0	T00	Nominal star input voltage	V	###
0x10E1	T01	Nominal star output voltage	V	###
0x10E2	T02	Nominal input frequency	Hz	##
0x10E3	T03	Nominal output frequency	Hz	##
0x10E4	T04	Firmware version of com. board (ex 1.00)	Integer *100	###.##
0x10E5	T05	Not used		
0x10E6	T06	Not used		
0x10E7	T07	Not used		
0x10E8	T08	Total nominal battery capacity (battery expansion cabinets included)	Ah*10	####.#
0x10E9	T09	Not used		
0x10EA	T10	Number of Power Share Plugs Available	Integer	#####
	T10÷T30	Not used		
0x10FF	T31	Not used		

Ox1000 value	UPS RANGE
20	MODULYS 1/1 MODULE
21	MODULYS 1/1 UPS
22	MODULYS 1/1 SYSTEM
26	MASTERYYS 1/1 SYSTEM
27	MASTERYYS 1/1 UPS
28	MASTERYYS 1/1 MODULE
29	NETYS
30	ITYS
31	NETYS RT
35	NETYS PR
36	NETYS PR-RK
37	NETYS PR-RT
82	MODULYS 3/1 MODULE
83	MODULYS 3/1 SYSTEM
84	MODULYS 3/1 UPS
86	MASTERYYS 3/1 SYSTEM
87	MASTERYYS 3/1 UPS
88	MASTERYYS 3/1 MODULE
89	ITYS 3/1 UPS
256	MASTERYYS 3/3 SYSTEM
257	MASTERYYS 3/3 UPS
258	MASTERYYS 3/3 MODULE
513 - 514	DELPHYS MP SINGLE UNIT
515 - 516	DELPHYS MX SINGLE UNIT
640	DELPHYS Green Power
644	DELPHYS BC
648	DELPHYS GP 2.0
1014 - 1017	DELPHYS MP SYSTEM
1018 - 1021	DELPHYS MX SYSTEM

APPENDIX: CONFIGURING NET VISION VIA SSH OR USB

SSH must be enabled in the NET VISION Control page.
Using SSH tool to open a terminal session:

login as: admin
admin@192.168.1.1's password:

Date 03/05/2017
Time 16:41:53

```
+=====+
|                                     |
|               Configuration Utility   |
|               [Socomec Net Vision 8.XX] |
+=====+
```

1. SNMP/WEB Card Settings
2. Reset Accounts/Passwords to Default
3. Reset Configuration to Default
4. Restart SNMP/WEB Card
0. Exit

Please Enter Your Choice =>

APPENDIX: NET VISION EXPLORER INSTALLATION

To get NET VISION Explorer, download it from the SOCOMEC website:

<https://socomec.co.uk/en-gb/net-vision-8-ups-websnmp-ethernet-card-iot-gateway>

Admin rights are necessary to install the NET VISION Explorer programme.

Run the NET VISION Explorer.exe file

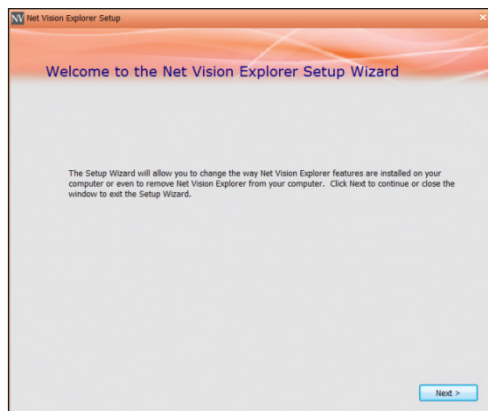

Follow the installation instructions.

The programme is installed by default to \Program Files\SOCOME

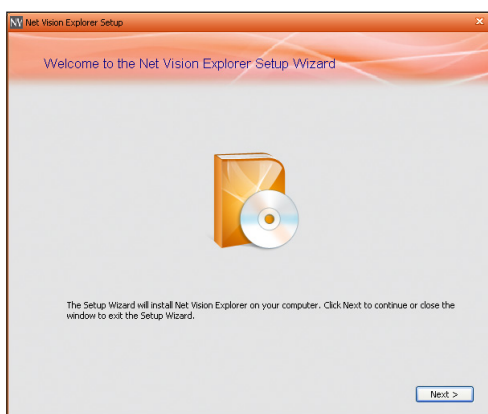

Running NET VISION Explorer



APPENDIX: GADGET SERIAL USB DRIVER INSTALLATION

First, download the installation package from the Socomec WEB site

1. Connect NET VISION to PC with mini USB cable.
2. PC will detect NET VISION as a USB device



3. Open device manager

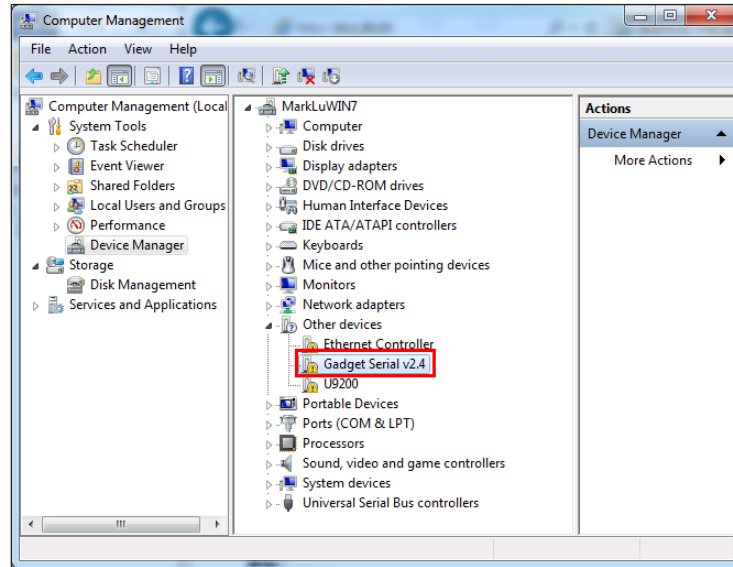

4. Double click on Gadget Device, select "Update Driver"
5. Select "Browse my computer for driver software" and select the driver stored on your computer.
6. Done

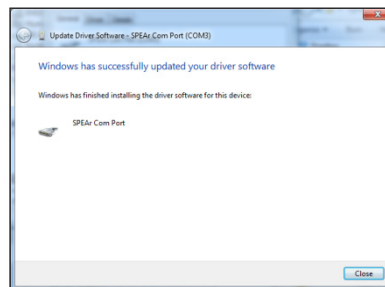

LED Definition

EMD and Network LEDs indicate the operating status of NET VISION as following:

Port	Green LED	Yellow LED	Description
Network	ON	Flashing(1sec)	Ethernet 100/1000 Traffic
	OFF	Flashing(1sec)	Ethernet 10 Traffic
	ON	ON	100 Base-TX Ready
	OFF	ON	10 Base-T Ready
	OFF	OFF	Ethernet Disconnection
Status/ EMD	OFF	Flashing ~1 second	UPS detection
	ON	OFF	UPS detected, no com with UPS
	ON	Flashing	Communication with UPS
	Two LEDs cross Flashing	Two LEDs cross Flashing	Auto Diagnostic Mode
	ON	ON	Auto Diagnostic Failed
	OFF	OFF	Hardware Error

Technical specification

Function	Description
Power Input	NV with USB (Host) function voltage: +7.5V ~ 40V
Power Consumption	3.0 Watts Maximum
SMT Switch	SMT switch on the board for configuration
Dimensions (L x W x H mm)	129.9(L) x 60.0(W) mm
Operating Temperature	-20 ~ 70° C
Operating Humidity	10 ~ 80 % (Non-condensing)

BACK VIEW

The BOX need to be powered via external power supply included in the package, or already installed in your UPS.

The 12V connector is located to the back of the box.



The serial link to UPS is located on the back of the box. The serial cable included in the package has to be connected to 'COM' RJ45 connector and to the UPS RS232 DB9 serial port.

The UPS serial COM port used for NET VISION BOX has to be set as following:

- Baud rate: 9600
- No parity
- MODBUS Slave 1

USB: Not Used

FRONT CONNECTION



The Network RJ45 connector is used for Ethernet network connection.

The EMD RJ45 is used to connect the optional EMD device. Refer to EMD Appendix;

USB: the NET VISION log can be stored on a USB memory stick.

SETUP: only for factory test or NET VISION programming (refer to Appendix).

APPENDIX: EMD OPTION DESCRIPTION

The EMD (Environmental Monitoring Device) is a connectivity device that allows you to remotely monitor the temperature, humidity, and status of two contact devices. Its connection to the NET VISION enables the monitoring and alarms notification.

1/ EMD INSTALLATION

Before connecting the EMD module: Set DIP switch 1 to the ON position on the back of the EMD device. It will be displayed as 'EMD 1'.

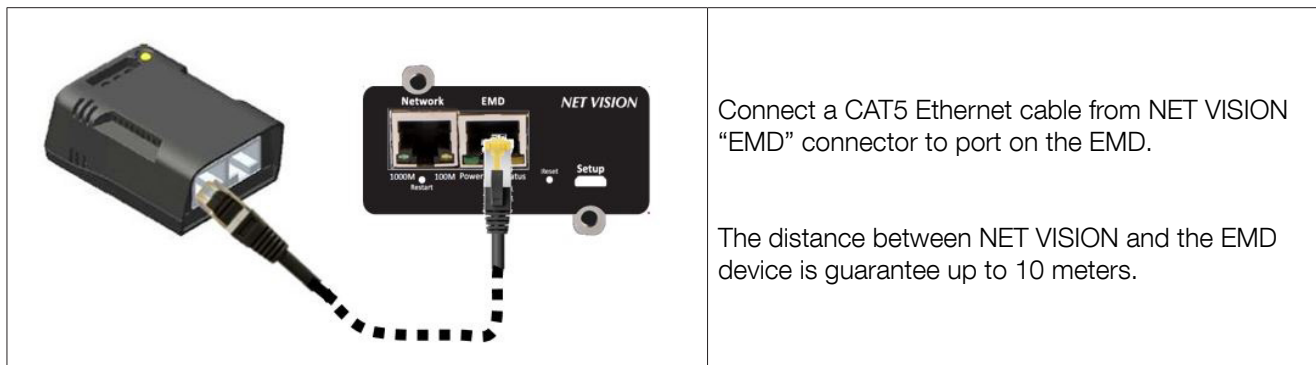

The EMD can be plugged while NET VISION is running.

2/ EMD CONFIGURATION

Once the EMD is connected to NET VISION, a new item appears in UPS Management menu.

Refer to EMD Device page for settings.

3/ EMD MONITORING

The EMD table is reported in the "EMD device" menu item

EMD History Log

The temperature and humidity coming from EMD device are report in the UPS History Log

EMD Temperature (°C)	EMD Humidity (%)
22.0	35.2

NET VISION Events Log

The 2 input alarms are reported in the NET VISION Events Log:

Event Time (dd/mm/yyyy hh:mm:ss) ▼	Event Level ▼	Event Description
Date time	Critical	EMD Alarm-1 activated
Date time	Information	EMD Alarm-1 not active
Date time	Critical	EMD Alarm-2 activated
Date time	Information	EMD Alarm-2 not active

4/ EMD Notifications

Temperature and Humidity thresholds low, high can be set for email and SNMP TRAP triggering.

Those events have to be selected in the event list

As Information:

- "EMD Sensor Not under low temperature"
- "EMD Sensor Not under low humidity"
- "EMD Input1 is restored"
- "EMD Sensor Not over high temperature"
- "EMD Sensor Not over high humidity"
- "EMD Input2 is restored"

As Critical

- "EMD Sensor detected low temperature"
- "EMD Sensor detected low humidity"
- "EMD Input1 is active"
- "EMD Sensor detected high temperature"
- "EMD Sensor detected high humidity"
- "EMD Input2 is active"

5/ Shutdown events

Additional EMD events are adding in the Shutdown event table for Server shutdown or warning function:

Shutdown Event	Shutdown Actions	Warning Period (Min)	1st Warning (Sec)	Warning Interval(Sec)
EMD Temperature	Disabled ▼	<input type="text"/>	<input type="text"/>	<input type="text"/>
EMD Humidity	Disabled ▼	<input type="text"/>	<input type="text"/>	<input type="text"/>
EMD Alarm-1	Warning ▼	<input type="text"/>	<input type="text"/>	<input type="text"/>
EMD Alarm-2	Client Shutdown ▼	<input type="text"/>	<input type="text"/>	<input type="text"/>

1. Serial Communication debug page

This page can be called in case of trouble with UPS communication.

[IP]/upsdebug.html

To start the communication debug it is necessary to be logged as admin.

The complete trace can be saved as CSV file on local computer.

Don't forget to disable the communication log before closing the page.

Sequence:

- enable the log, checking the Enable box;
- click on apply;
- wait for the log fill-up (at least 10 minutes or more);
- disable the logging unchecking the Enable box;
- click on apply;
- click on Export Table button;
- save the file.

2. Email sending debug page

This page can be called in case of trouble sending email.

[IP]/mailDebug.html

Email error code list

Code	Meaning	How to solve it / what to do
001	Cannot connect to mail server	Confirm SNMP card has ability to connect to internet. Check the mail server or DNS type correctly
002	Unknown error	
101	The server is unable to connect.	Try to change the server's name (maybe it was spell incorrectly) or the connection port.
111	Connection refused or inability to open an SMTP stream.	This error normally refers to a connection issue with the remote SMTP server, depending on firewalls or misspelled domains. Double-check all the configurations and in case ask your provider.

For more info refer to smtp server error list: <http://www.serversmtp.com/en/smtp-error>

3. Gmail account configuration

Gmail accounts needs to enable TLS and authentication by NET VISION and make sure that the network is able to access to Internet.

Google new account policy (June, 2022):

Step 1: log on your Gmail account.

Step 2: In 'Security' item: switch '2-Step verification' to ON

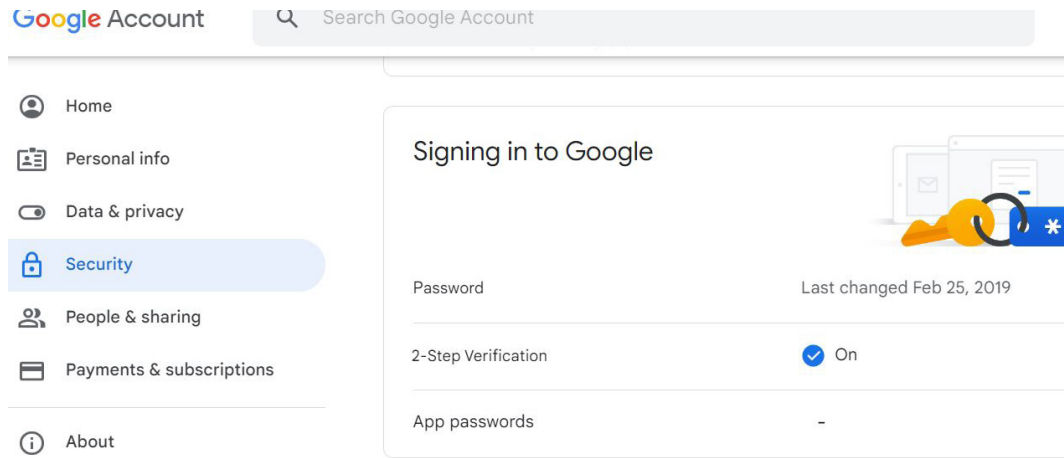

Step 3: In App password: Select 'Other' in Device list, enter 'NetVision' as device name and click on 'GENERATE'

Step 4: copy the password generated

Step 5: paste this password in 'User Password' of Net Vision SMTP account settings page.

Step 6: Fill other SMTP settings for Gmail account and apply.

Net Vision is now able sending email to your Gmail account.

Mail Server	smtp.gmail.com
User Account	-----
User Password	●●● report here the psw generate in Gmail account
Sender Email Address	-----@gmail.com
Mail Subject Prefix	UPS Notification
DNS Address	8.8.8.8
Mail Daily Status Report At (hh:mm)	00:00
Mail support TLS	Enabled ▾
Mail support Authentication	Enabled ▾
Delay before sending (minute)	0

Socomec: our innovations supporting your energy performance

1 independent manufacturer

3,600 employees worldwide

10 % of sales revenue dedicated to R&D

400 experts dedicated to service provision

Your power management expert



POWER SWITCHING



POWER MONITORING



POWER CONVERSION



ENERGY STORAGE



EXPERT SERVICES

The specialist for critical applications

- Control, command of LV facilities
- Safety of persons and assets
- Measurement of electrical parameters
- Energy management
- Energy quality
- Energy availability
- Energy storage
- Prevention and repairs
- Measurement and analysis
- Optimisation
- Consultancy, commissioning and training

A worldwide presence

12 production sites

- France (x3)
- Italy (x2)
- Tunisia
- India
- China (x2)
- USA (x3)

28 subsidiaries and commercial locations

- Algeria • Australia • Belgium • China • Canada
- Dubai (United Arab Emirates) • France • Germany
- India • Indonesia • Italy • Ivory Coast • Netherlands
- Poland • Portugal • Romania • Serbia • Singapore
- Slovenia • South Africa • Spain • Switzerland
- Thailand • Tunisia • Turkey • UK • USA

80 countries

where our brand is distributed

HEAD OFFICE

SOCOMECC GROUP

SAS SOCOMECC capital 10 607 040 €
R.C.S. Strasbourg B 548 500 149
B.P. 60010 - 1, rue de Westhouse
F-67235 Benfeld Cedex
Tel. +33 3 88 57 41 41 - Fax +33 3 88 57 78 78
info.scp.isd@socomecc.com

www.socomecc.com



UK OFFICE

SOCOMECC U.K. Limited

Power Conversion (UPS)
7-9 Lakeside Business Park,
Broadway Lane, South Cerney,
Gloucestershire, GL7 5XL
Tel. +44 (0) 333 015 3002
info.uk@socomecc.com

UK
CA

YOUR DISTRIBUTOR / PARTNER

100 years
OF SHARED ENERGY

socomecc
Innovative Power Solutions