



DIRIS A60

Multifunction meters - PMD

energy monitoring and event analysis - dimensions 96 x 96 mm

Single-circuit metering,
measurement &
analysis



DIRIS A60

Principle diagram

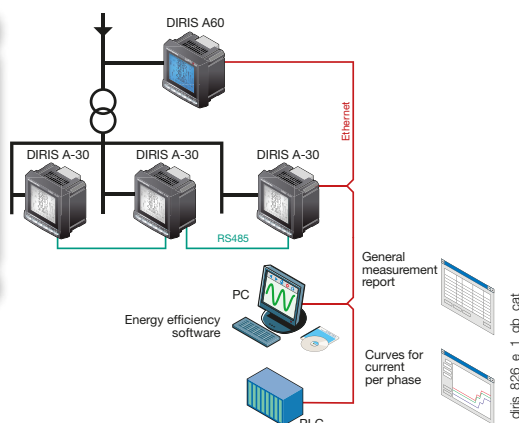

The solution for

- > Industry
- > Infrastructure
- > Data centre



Strong points

- > Easy to use
- > Detects wiring errors
- > Compliant with IEC 61557-12
- > Management software
- > Conformity to standard EN 50160

Conformity to standards

- > IEC 61557-12
- > IEC 62053-22 class 0.5S
- > IEC 62053-23 class 2
- > EN 50160



Function

DIRIS A60 is a panel mounted multifunction meter which incorporates all functions of the DIRIS A-30 with the addition of enhanced data logging functions, recording curves for quality events. All this information can be analysed remotely using the Analysis software which is available at no charge and can be downloaded from the SOCOMEC website www.socomec.com.

Advantages

Easy to use

Thanks to its large backlit LCD display and its multiple viewing screens with direct key access, the DIRIS A60 provides clear readings and is easy to use.

It directly displays a number of multi-measurement and metering values : +/- kWh, +/- kvarh, kVAh, I, U, V, F, P, Q, S, PF, etc.

Detects wiring errors

An integrated test function can be utilised to detect incorrect wiring and to automatically correct CT installation errors.

Compliant with IEC 61557-12

IEC 61557-12 is a high-level standard for all PMDs (Performance Monitoring Devices) that are designed to measure and monitor electrical parameters in distribution networks.

Compliance with IEC 61557-12 ensures a high level of equipment performance, in terms of metrology, and the mechanical and environmental aspects (EMC, temperature, etc.).

Management software

- Optional Ethernet module with Webserver function: For measurement monitoring, data exploitation and the export of load curves remotely without a specific software (web browser access).
- Analysis software: For the analysis of events data in order to improve the reliability of the electrical installation.
- Easy Config software: For quick and easy remote device configuration; configuration files can be copied from and sent to the DIRIS A60, or they can be created without communication and sent at a later time. Multiple devices can be configured from a single file, which is especially useful for OEMs and panel builders.

Conformity to standard EN 50160

EN 50160 is a standard which defines events relating to the quality of electrical networks. The DIRIS A60 captures voltage events in accordance with this standard.

Functions

In addition to the functions of the DIRIS A-30, the DIRIS A60 also:

- shows the current and voltage unbalance
- shows the tangent φ
- stores the load curves (60 days with an interval of 10 minutes) for the active, reactive and apparent power: ΣP +/-; ΣQ +/-; ΣS
- detects and stores the last 40 events concerning:
 - overvoltage
 - voltage dips
 - cut-offs
 - overcurrent.

For each stored event, the DIRIS A60 records the relevant RMS 10 ms interval curves for the voltages V1, V2, V3, U12, U23, U31 and the currents I1, I2, I3, In, giving a total of 400 curves.

Other functions:

Multi-measurement

Currents

- instantaneous: I1, I2, I3, In, Isystem,
- average/maximum average: I1, I2, I3, In,
- unbalance: I unb.
- Voltages & frequency
 - instantaneous: V1, V2, V3, U12, U23, U31, F, Vsystem, Ussystem
 - average/maximum average: V1, V2, V3, U12, U23, U31, F
 - unbalance: U unb.
- Power
 - instantaneous: 3P, ΣP , 3Q, ΣQ , 3S, ΣS
 - maximum average: ΣP , ΣQ , ΣS
 - predictive: ΣP , ΣQ , ΣS .
- Power factor - PF, ΣPF
- Instantaneous total tangent φ
- Instantaneous, average and max. average unbalance

- Temperatures⁽¹⁾

- internal,
- external via 3 PT100 sensors

Metering

- Active energy: +/- kWh
- Reactive energy: +/- kvarh
- Apparent power: kVAh
- Hours: \odot

Harmonic analysis (level 63)

- Total harmonic distortion
 - Currents: thd I1, thd I2, thd I3, thd In
 - Phase-to-neutral voltage: thd V1, thd V2, thd V3
 - Phase-to-phase voltage: thd U12, thd U23, thd U31
- Individual
 - Currents: HI1, HI2, HI3, HIn
 - Phase-to-neutral voltage: HV1, HV2, HV3,
 - Phase to phase voltage: HU12, HU23, HU31

Events⁽¹⁾

- Alarms on all electrical values

Communications⁽¹⁾

- 0/4- 20 mA analogue output
- RS485 MODBUS RTU
- Ethernet (MODBUS TCP or MODBUS RTU over TCP and Webserver)
- Ethernet (MODBUS TCP or MODBUS RTU over TCP and Webserver) with RS485 MODBUS RTU gateway

Inputs / Outputs⁽¹⁾

- Pulse metering
- Remote control/command
- Alarm report
- Pulse report

⁽¹⁾ Available as an option (see the following pages).

Front panel



1. Backlit LCD display.
2. Direct access key for currents, temperatures and test function.
3. Direct access key for voltages and frequency.
4. Direct access key for active, reactive, and apparent powers and power factor.
5. Direct access key for maximum and average current, voltage and power values.
6. Direct access key for harmonics values.
7. Direct access key for energies, hour meter and programming menu.

Plug-in modules

DIRIS® A60*

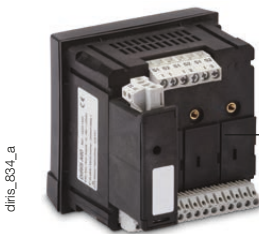

* With integrated memory module.

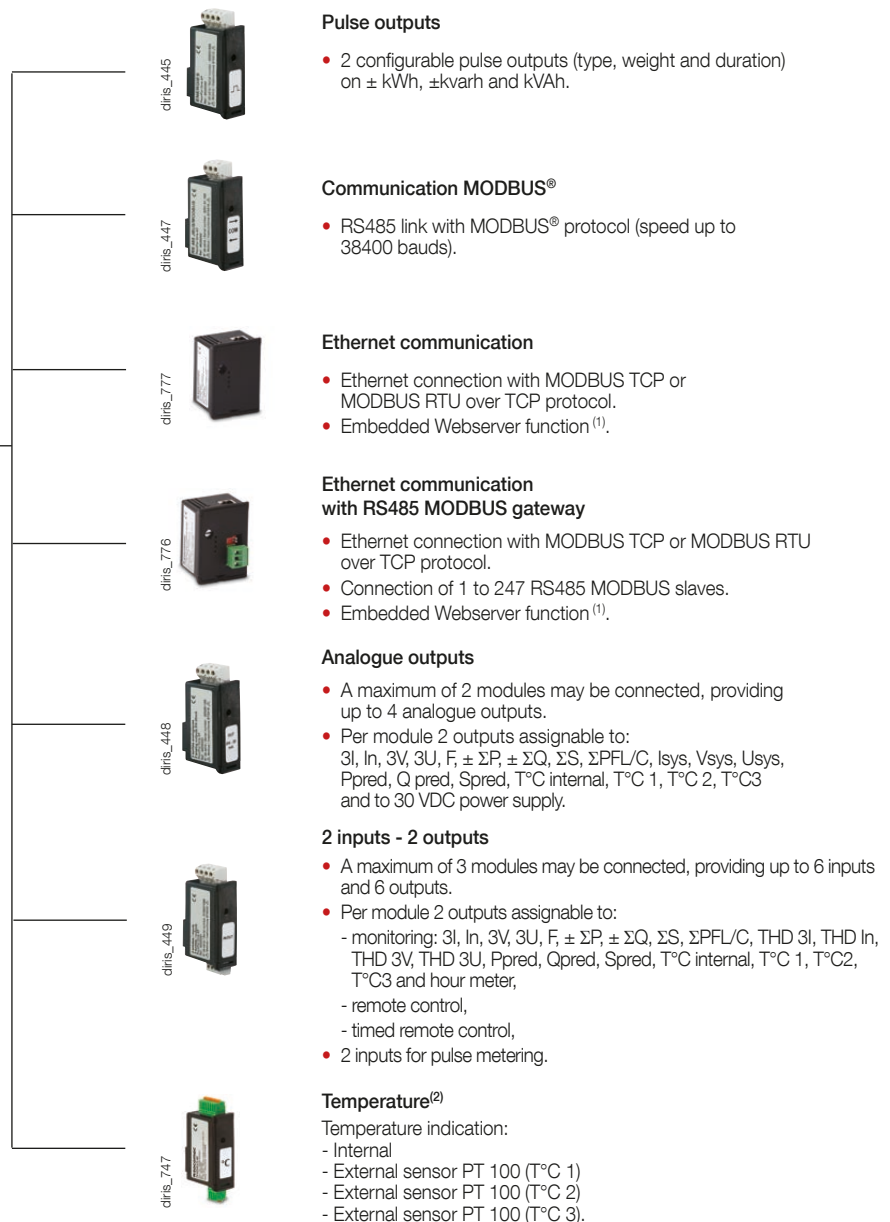

⁽¹⁾ See "Management software tools" pages.

⁽²⁾ See "External sensor PT 100".

DIRIS A60

Multifunction meters - PMD

energy monitoring and event analysis - dimensions 96 x 96 mm

Accessories

Current transformers



trafo_024

Split-core current transformers



trafo_077

IP65 protection



DIRIS_720

Panel mounting kit for a 144 x 96 mm cut-out



DIRIS_718

Terminals

DIRIS A60

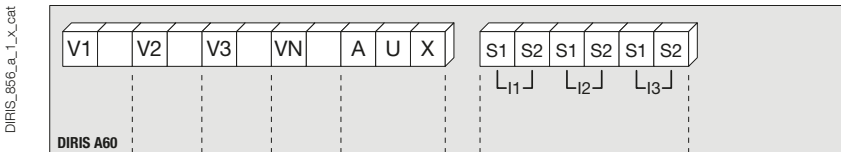

S1 - S2: current inputs

AUX: auxiliary power supplies U_s
V1 - V2 - V3 - VN: voltage inputs

RS485 MODBUS module

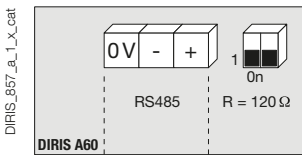

RS485 link.

R = 120 Ω: selectable internal resistance for RS485 end of line termination.

Ethernet module

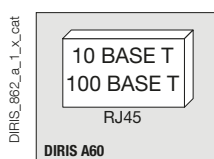

Ethernet module + RS485 MODBUS gateway

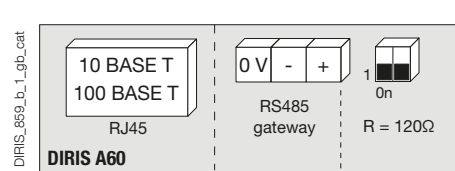

RS485 gateway resistor.

R = 120 Ω: selectable internal resistance for RS485 end of line termination.

Pulse output module

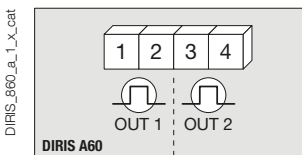

1 - 2: pulse output n°1.
3 - 4: pulse output n°2.

Temperature module

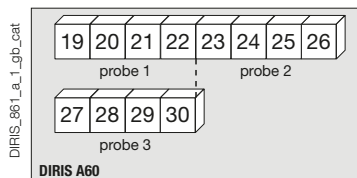

2 inputs / 2 outputs module

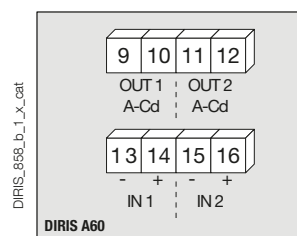

9 - 10: relay output n°1.
11 - 12: relay output n°2.
13 - 14: opto input n°1.
15 - 16: opto input n°2.

Analogue output module

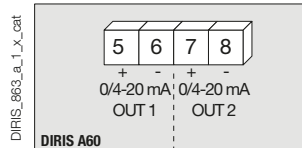

5 - 6: analogue output n°1.
7 - 8: analogue output n°2.

Electrical characteristics

Current measurement on insulated inputs (TRMS)	
Via CT primary	9 999 A
Via CT secondary	1 or 5
Measurement range	0 ... 11 kA
Input consumption	≤ 0.1 VA
Measurement updating period	1 s
Accuracy	0.2 %
Permanent overload	6 A
Intermittent overload	10 I _n for 1 s
Voltage measurements (TRMS)	
Direct measurement between phases	50 ... 700 VAC
Direct measurement between phase and neutral	28 ... 404 VAC
VT primary	500 000 VAC
VT secondary	60, 100, 110, 173, 190 VAC
Frequency	50 / 60 Hz
Input consumption	≤ 0.1 VA
Measurement updating period	1 s
Accuracy	0.2 %
Permanent overload	800 VAC
Current-voltage product	
Limitation for 1A CT	10 000 000
Limitation for 5A CT	10 000 000
Power measurement	
Measurement updating period	1 s
Accuracy	0.5 %
Power factor measurement	
Measurement updating period	1 s
Accuracy	0.5 %
Frequency measurement	
Measurement range	45 ... 65 Hz
Measurement updating period	1 s
Accuracy	0.1 %
Energy accuracy	
Active (according to IEC 62053-22)	Class 0.5 S
Reactive (according to IEC 62053-23)	Class 2
Auxiliary power supply	
Alternating voltage	110 ... 400 VAC
AC tolerance	± 10 %
Direct voltage	120 ... 350 VDC
DC tolerance	± 20 %
Frequency	50 / 60 Hz
Consumption	≤ 10 VA

2 inputs / 2 outputs module: Outputs (alarms / control)	
Number of relays	2 ⁽¹⁾
Type	250 VAC - 5 A - 1150 VA
2 inputs / 2 outputs module: Phototransistor inputs (pulse metering)	
Number	2 ⁽¹⁾
Power supply	10 ... 30 VDC
Minimum signal width	10 ms
Minimum duration between 2 pulses	18 ms
Type	phototransistors
Pulse output module	
Number of relays	2
Type	100 VDC - 0.5 A - 10 VA
Max. number of operations	≤ 10 ⁸
Analogue output module	
Number of outputs	2 ⁽²⁾
Type	insulated
Range	0 / 4 ... 20 mA
Load resistance	600 Ω
Maximum current	30 mA
MODBUS communication module	
Link	RS485
Type	2 ... 3 half duplex wires
Protocol	MODBUS RTU
MODBUS [®] speed	4800 ... 38400 bauds
Ethernet communication module	
Connection	RJ45
Speed	10 base T / 100 base T
Protocol	MODBUS TCP or MODBUS RTU over TCP
Temperature inputs	
Type	PT100
Connection	2, 3 or 4 wires
Dynamic	- 20 ... 150 °C
Accuracy	± 1 digit
Maximum length	300 cm
Operating conditions	
Operating temperature	- 10 ... + 55 °C
Storage temperature	- 20 ... + 85 °C
Relative humidity	95 %

(1) Max. 3 modules / DIRIS.

(2) Max. 2 modules / DIRIS.

Case

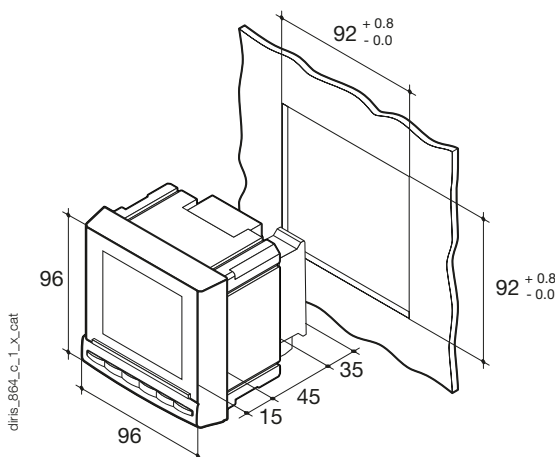

Type	panel mounting
Dimensions W x H x D	96 x 96 x 80 mm
Case degree of protection	IP30
Front degree of protection	IP52
Display type	backlit LCD display
Terminal blocks type	fixed or plug-in
Voltage and other terminals connection cross-section	0.2 ... 2.5 mm ²
Current connection cross-section	0.5 ... 6 mm ²
Weight	450 g

DIRIS A60

Multifunction meters - PMD

energy monitoring and event analysis - dimensions 96 x 96 mm

Connection

Low voltage balanced network for DIRIS A60

Recommendation: When disconnecting the DIRIS, the secondary of each current transformer must be short-circuited. This operation can be carried out automatically by a SOCOMEC PTI, which can be found in the SOCOMEC catalogue: please consult us.

3/4 wires with 1 CT

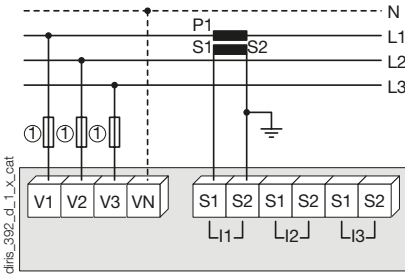

Use of 1 CT reduces by 0.5% the accuracy of the phases, the current of which is worked out by vector calculation.

1. Fuses 0.5 A gG / 0.5 A class CC.

Single-phase

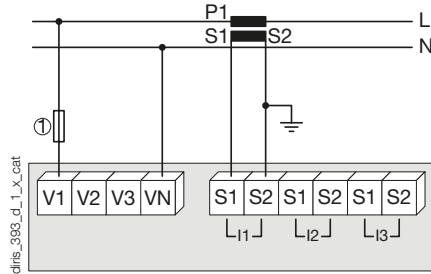

1. Fuses 0.5 A gG / 0.5 A class CC.

Two-phase

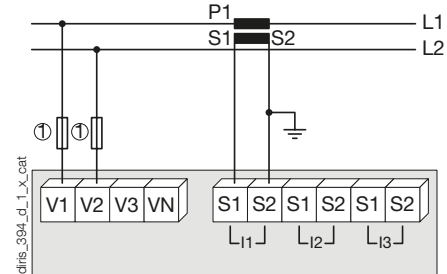

1. Fuses 0.5 A gG / 0.5 A class CC.

Low voltage unbalanced network for DIRIS A60

3/4 wires with 3 CTs

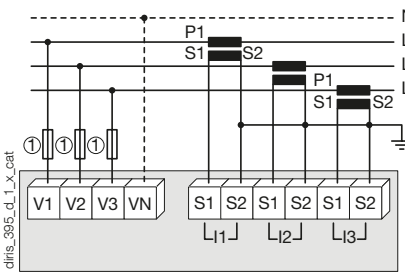

1. Fuses 0.5 A gG / 0.5 A class CC.

3 wires with 2 CTs

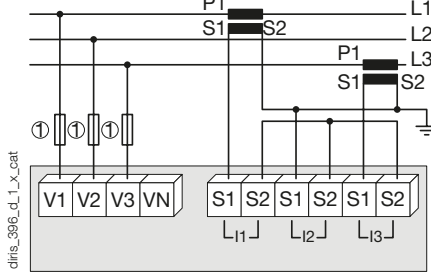

Use of 2 CTs reduces by 0.5% the accuracy of the phases, the current of which is worked out by vector calculation.

1. Fuses 0.5 A gG / 0.5 A class CC.

3 wires with 2 CTs

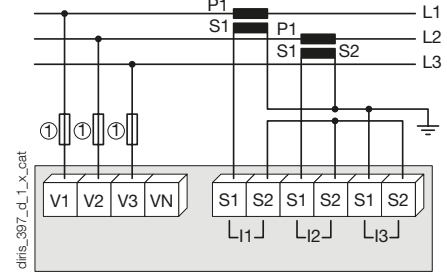

Use of 2 CTs reduces by 0.5% the accuracy of the phases, the current of which is worked out by vector calculation.

1. Fuses 0.5 A gG / 0.5 A class CC.

Additional information

Communication via RS485 link

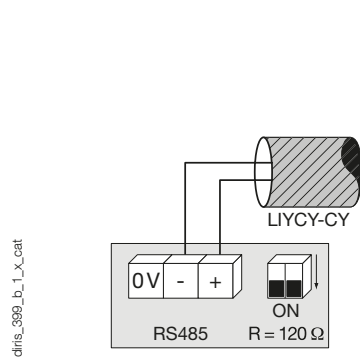

Connection of voltage transformer for HV networks

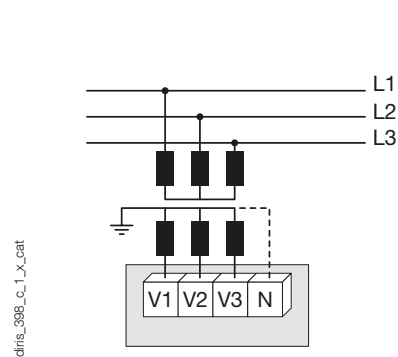

AC & DC auxiliary power supply

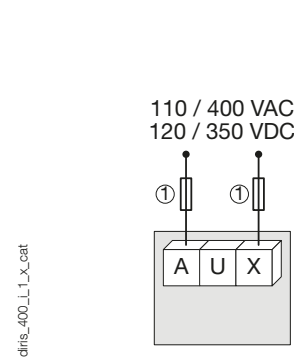

1. Fuses 0.5 A gG / 0.5 A class CC.

References

Basic device	DIRIS A60
Auxiliary power supply U_s	Reference
110 ... 400 VAC / 120 ... 350 VDC	4825 0207
Options	
Plug-in-modules⁽¹⁾	Reference
Pulse outputs	4825 0090
RS485 MODBUS [®] communication	4825 0092
Analogue outputs	4825 0093
2 inputs / 2 outputs	4825 0094
Ethernet communication (embedded Ethernet Webserver) ⁽²⁾	4825 0203
Ethernet communication + RS485 MODBUS gateway (embedded Ethernet Webserver) ⁽²⁾	4825 0204
Temperature inputs	4825 0206

(1) Easy integration of additional functions (maximum 3 slots per device).

(2) Dimension of the plug-in module: 2 slots.

Options	To be ordered in multiples of	Reference
Description of accessories		
IP65 protection	1	4825 0089
Panel mounting kit for a 144 x 96 mm cut-out	1	4825 0088
Fuse disconnect switches for the protection of voltage inputs (type RM) 3 poles	4	5601 0018
Fuse disconnect switches for the protection of the auxiliary supply (type RM) 1 pole + neutral	6	5601 0017
Fuse type gG 10 x 38 0.5 A	10	6012 0000
Ferrite to be associated with communication modules	1	4899 0011
Current transformer range	1	See "TE sensors" pages
Temperature sensor PT100 - M6 screw type	1	4825 0208
Temperature sensor PT100 - M6 eyelet type	1	4825 0209
Management software for DIRIS		See "Management software tools" pages

Expert Services

- > Study, definition, advice, implementation, maintenance and training... Our experts "Expert Services" offer complete support for the success of your project.

