

Smart insulation monitoring solution for unearthed IT systems

ISOM Digiware



The advantages of the IT system

Greater monitoring and performance for your electrical installations

Choose an unearthed IT system and make power distribution availability a priority. This will give you constant control over the electrical distribution and its insulation from earth, no matter what happens. Your electrical installation will be more stable and more reliable.



Service continuity even in case of first insulation fault



Predictive maintenance



Protection of assets and people



Low fire and explosion risks

Expert support



ISOM Digiware

Take Digiware to the next level

ISOM Digiware, the first revolutionary system combining insulation monitoring and power monitoring

2 in 1

- The first revolutionary system with both insulation monitoring and power monitoring of circuits.
- Compatible with ISOM and DIRIS Digiware modules.
- A full solution that is easy to install with an improved monitoring of IT systems.

Performance

- Customisable functions and performance.
- Scalable system, with easy addition of Digiware modules.
- Suitable for any system size: medical facilities, extended power networks...
- Precise and fast location of insulation faults.

Predictive

- OhmScanner technology: mapping of the insulation.
- Detects insulation degradations and anticipates real insulation faults.
- Continuous monitoring of the insulation level of each circuit.
- Simultaneous analysis of insulation and power monitoring parameters to identify correlations and clarify the source of insulation faults.

Design your own insulation monitoring system

for distribution networks and medical facilities

A single point of access to readings and alarms for local and remote analysis

1



ISOM Digiware D

Bluetooth

WEBVIEW-M

Acquisition modules for voltage, current and inputs/outputs⁽¹⁾

2



DIRIS Digiware U

DIRIS Digiware I

DIRIS Digiware IO

A module for insulation monitoring and fault locating signal injection

3



ISOM Digiware L

Modules for insulation fault location and power monitoring

4



ISOM Digiware F

Locating core balance transformers and current sensors

5



Locating core balance transformers ΔIP with T-15 adapter

Current sensors TE, TR, TF

A portable insulation fault location system to track faults down to secondary outgoing circuits

6



Fault location equipment ISOM FP-60

(1) See the DIRIS Digiware range.

ISOM Digiware system for medical facilities

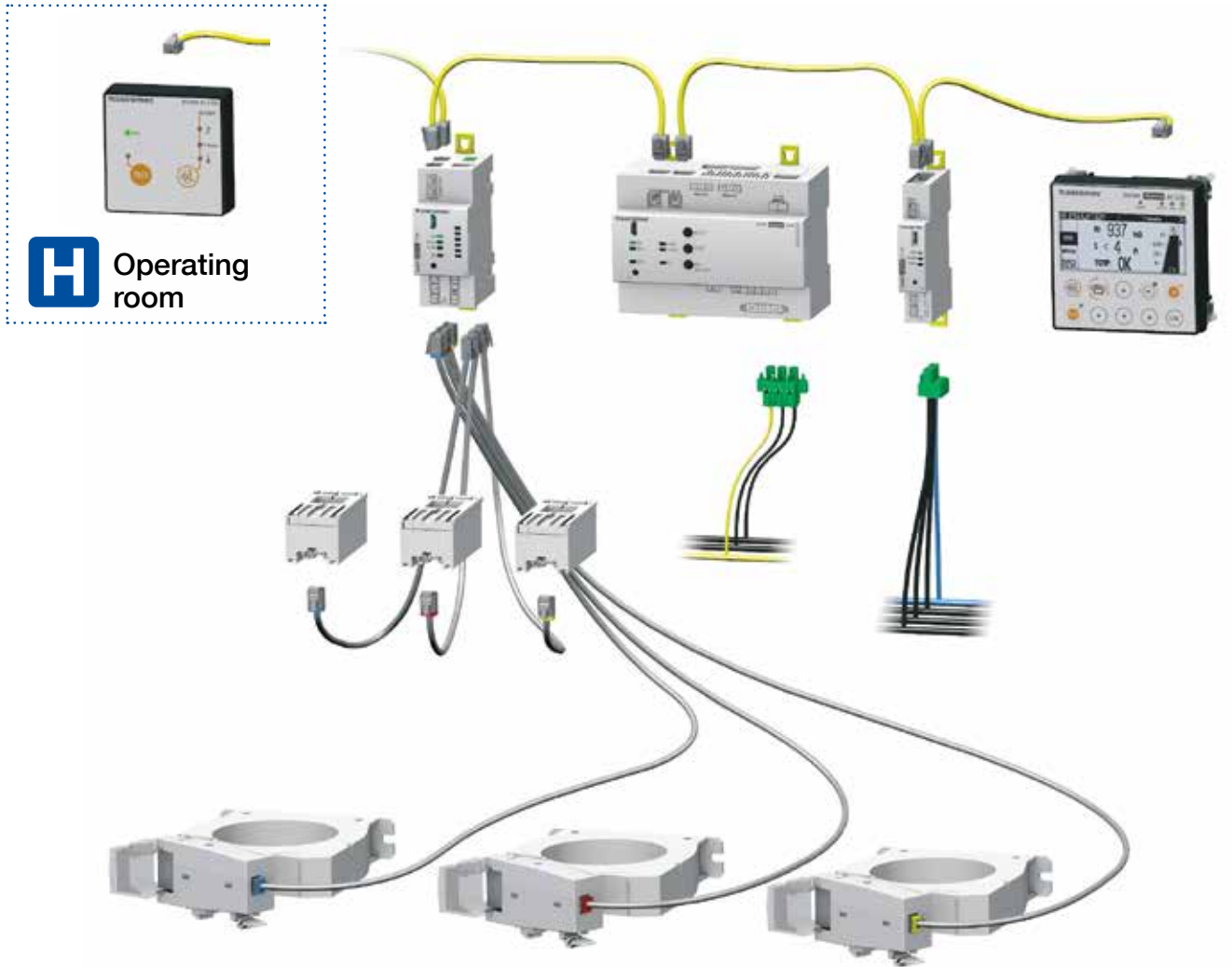

ISOM DW 041 A

The solution for



Hospitals

Locating insulation faults across the entire electrical installation



ISOM 499 A

ISOM FP-60 is the stand-alone and portable solution to locate faults on any type of electrical network. Compatible with the ISOM Digiware L-60 permanently installed system and the ISOM JP-61 portable injector.

ISOM Digiware system for power networks or control circuits

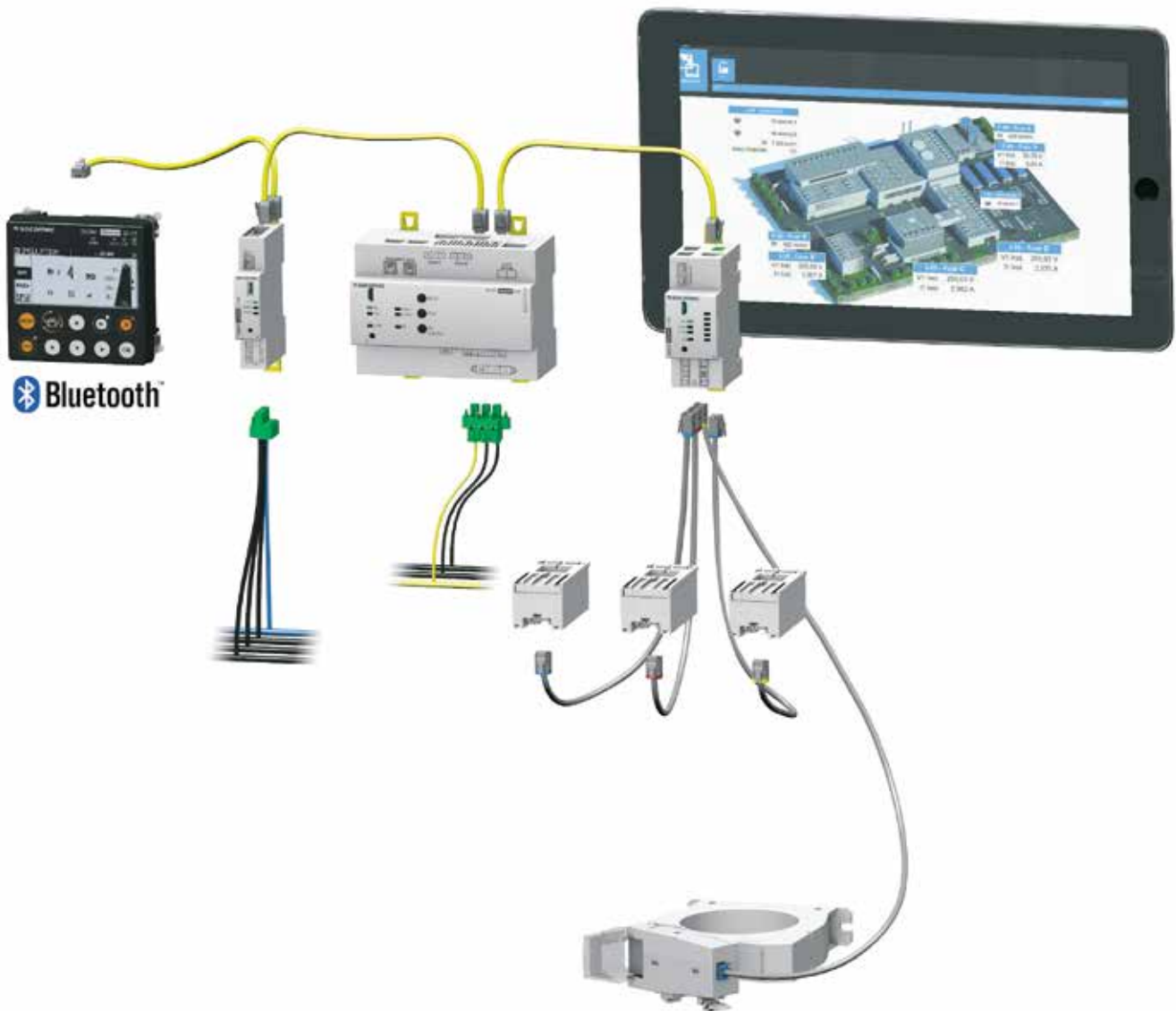

ISOM DW 041 A

The solution for



Naval and
military
infrastructures



Rail and
aeronautic
infrastructures



Process/
manufacturing
industries



Oil & gas
industries



Energy
production

Single point of access to measurement data and alarms

ISOM Digiware D

ISOM Digiware D remote screens give you:

- a local view of the data measured by the ISOM Digiware L-60, F-60 and DIRIS Digiware U, I, IO,
- a 24 VDC power supply to the entire ISOM Digiware system,
- the gateway function: access to data via Ethernet (D-55/D-75).



Bluetooth sensors

The B-TRH and B-MAG are sensors that communicate with ISOM Digiware D displays wirelessly via Bluetooth.



The B-TRH sensor monitors ambient temperature and humidity and alerts you if high levels are exceeded.



The B-Mag sensor alerts you in case the door of an electrical panel or restricted technical room is opened.

Multi-display

- A centralised visualisation point for measurement data of the entire system.
- One screen showing insulation levels and measurements of circuits.

EMS embedded

- Analysis and monitoring software WEBVIEW-M integrated in the D-75.

IOT ready

- Automatic export of data via FTPS.
- Bluetooth connectivity for collecting and viewing data from environmental sensors.

| | ISOM Digiware D-55 | ISOM Digiware D-75 | ISOM Digiware D-55h |
|------------------|--|--------------------|--|
| Application | Power distribution | | Medical facilities |
| Inputs | Digiware /RS485 | Digiware /RS485 | Digiware /RS485 |
| Outputs | Ethernet /RS485 | | |
| Protocols | Modbus TCP | | |
| Webserver | WEBVIEW-M | | |
| Alarm management | Multipoint | Multipoint | Multipoint Alarm reporting function (operating room etc.) |
| Accessories | Retrofit frame for DIN 144 x 96 mm panel mounting (ISOM ALD 590 replacement) | | Mounting kit for integration inside partition walls |
| | IP65 flexible cover for 144 x 96 mm retrofit frame | | |

Alarm report indicator for medical locations ISOM D-15h



As an add-on to ISOM Digiware D-55h, the ISOM D-15h provides a visual and audible alarm report in rooms with medical use if there is an insulation fault within the medical IT system, or in case of overheating or overload on the isolating power transformer.

2 Voltage acquisition module

DIRIS Digiware U

DIRIS Digiware U modules acquire voltage for the entire DIRIS Digiware system. They provide access to energy and power features on ISOM Digiware F & DIRIS Digiware I modules. The RJ45 Digiware bus carries the voltage measurements and the power supply for all connected modules. You can use the ISOM Digiware system without DIRIS Digiware U modules.



A comprehensive solution dedicated to the metering and monitoring of voltages, and to the analysis of the incoming voltage quality.



No hazardous voltage on electrical panel doors.

| Applications | Measuring alternating current voltage | | |
|---|---------------------------------------|----------------|----------------|
| | Metering | Monitoring | Analysis |
| DIRIS Digiware U | U-10 | U-20 | U-30 |
| Measuring range (min-max) | 50-300 VAC Ph/N | | |
| Multi-measurement | | | |
| U12, U23, U31, V1, V2, V3, f | • | • | • |
| U system, V system | | | • |
| Ph/N & Ph/Ph unbalance | | | • |
| Quality | | | |
| THD U, THD V | | • | • |
| Individual harmonics U/V | | | • |
| Voltage dips, swells and interruptions (EN 50160) | | | • |
| Alarms (threshold) | | | • |
| Log of average measurements | | | • |
| Format/Number of modules | 18 mm/1 | 18 mm/1 | 18 mm/1 |

Digiware ecosystem

The DIRIS Digiware I and IO modules allow you to extend the functionality of your system. Adding a DIRIS Digiware I module for specific loads gives you additional features including power quality monitoring, customisable alarms and measurement logs.

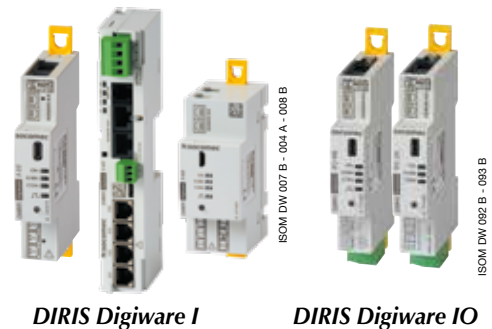

3 Module for insulation monitoring and fault location signal injection



ISOM Digiware L-60

ISOM Digiware L-60 modules combine the functions of Insulation Monitoring Device (IMD) and the Location Current Injector (LCI). They provide a continuous monitoring of power networks and medical facilities. Their self-adaptive measuring principle guarantees operation no matter how strong the network disturbances are.



APPLI 885 A

ISOM-DW 004



This device monitors the overall insulation of the electrical installation and automatically triggers a regular and detailed mapping of the insulation of each circuit.



Use the pushbutton on the front face to easily and quickly start the injection of the location signal when using a portable system.



The system voltage measurements are transmitted via the Digiware bus to the F-60 fault locating modules, for a better insight into the insulation (resistive and capacitive evaluation).

| | ISOM Digiware L-60 | ISOM Digiware L-60t | ISOM Digiware L-60h |
|--|--------------------|---------------------|---------------------|
| Application | Power distribution | Power distribution | Medical facilities |
| Heavy-duty model for extreme environments (humidity, impact, vibrations) | | • | |
| Threshold values | 0.5 - 1000 kΩ | 0.5 - 1000 kΩ | 50 - 500 kΩ |
| Maximum permissible leakage capacity | 300 μF | 300 μF | 10 μF |
| Temperature monitoring | | • | |
| Inputs/outputs | | 4 configurable | |
| Log of average measurements Rf, Ce | | • | |
| Format/Number of modules | 125 mm/7 | 125 mm/7 | 125 mm/7 |

Modules for insulation fault location and power monitoring

ISOM Digiware F-60

ISOM Digiware F-60 modules locate permanent, fugitive and highly resistive insulation faults. They detect the locating signal generated by the ISOM Digiware L-60 through Δ IP locating core balance transformers equipped with an ISOM T-15 adapter. The ISOM Digiware F-60 can also be used with smart current sensors TE, TR and TF. ISOM Digiware F-60 has 6 inputs to monitor the insulation of 6 circuits or to combine insulation monitoring and power monitoring of a three-phase circuit or 3 single-phase circuits.



ISOM DW 001 A

Mutualised functions

The module combines insulation fault location and power monitoring for multiple circuits.

Simultaneous scanning

The scan is simultaneous and fast on all 6 circuits. Individual LEDs indicate which circuit is faulty.

Plug & play

The sensors are quick to connect and without tools, thanks to an RJ12 connection.

| | ISOM Digiware F-60 | ISOM Digiware F-60t |
|--|-------------------------------------|---------------------|
| Application | Power distribution/medical facility | Power distribution |
| Heavy-duty version for extreme environments (humidity, impact, vibrations) | | • |
| Measures load and insulation | 6 inputs | 6 inputs |
| Output | NOC relay | NOC relay |
| Log of average measurements Rf, Ce, I _L | • | • |
| Format/Number of modules | 36 mm/2 | 36 mm/2 |
| Metering | | |
| +/- kWh, +/- kVarh, kVAh | • | • |
| Multi-tariff (max. 8) | • | • |
| Load curves | • | • |
| Multi-measurement | | |
| I1, I2, I3, In, ΣP, ΣQ, ΣS, ΣFP | • | • |

5 Current sensors



Smart sensors

- Sensors with an extended operational range.
- Automatic rating configuration.
- Safe disconnection of the current sensor under load.
- Fast connection via RJ12 and identification of cables by colour-coding.



Compact

- The most compact in the market.
- Linear assembly.
- Staggered assembly.
- Match the pitch of protective devices.



PreciSense

Guaranteed accuracy in accordance with the IEC 61557-12 standard: class 0.5 for the global measurement chain, from 2 to 120% of I_n .

| | TE solid-core sensors | Rated currents (A) | | | | | | | | | | | Real range covered (A) | Pitch (mm) | Aperture (mm) | Dimensions (mm) | | | | |
|---|-----------------------|--------------------|----|----|----|----|-----|-----|-----|-----|-----|------|------------------------|------------|---------------|-----------------|--------------|----|-------------|-----------------|
| | | 5 | 20 | 25 | 40 | 63 | 160 | 250 | 400 | 600 | 630 | 1000 | | | | | 2000 | | | |
|  | TE-90 | | | | | | | | | | | | | | | | 12 ... 2400 | 90 | 64 x 64 | 126 x 90 x 24.6 |
| | TE-55 | | | | | | | | | | | | | | | | 8 ... 1200 | 55 | 41 x 41 | 100 x 55 x 32.5 |
| | TE-45 | | | | | | | | | | | | | | | | 3.2 ... 756 | 45 | 31 x 31 | 86 x 45 x 32.5 |
| | TE-35 | | | | | | | | | | | | | | | | 1.26 ... 300 | 35 | 21 x 21 | 71 x 35 x 32.5 |
| | TE-25 | | | | | | | | | | | | | | | | 0.8 ... 192 | 25 | 13.5 x 13.5 | 65 x 25 x 32.5 |
| | TE-18 | | | | | | | | | | | | | | | | 0.5 ... 75 | 18 | Ø 8.6 | 45 x 28 x 20 |
| | TE-18 | | | | | | | | | | | | | | | | 0.1 ... 24 | 18 | Ø 8.6 | 45 x 28 x 20 |

| | TR / iTR split-core sensors | Rated currents (A) | | | | | Real range covered (A) | Aperture (mm) | Dimensions (mm) | |
|---|-----------------------------|--------------------|----|----|-----|-----|------------------------|---------------|-----------------|--------------|
| | | 25 | 40 | 63 | 160 | 250 | | | | 600 |
|  | TR-32 | | | | | | | | Ø 32 | 53 x 86 x 47 |
| | TR-21 | | | | | | | | Ø 21 | 37 x 65 x 43 |
| | TR-14 | | | | | | | | Ø 14 | 29 x 67 x 28 |
| | TR-10 | | | | | | | | Ø 10 | 26 x 44 x 28 |

| | TF flexible sensors | Rated currents (A) | | | | | | Real range covered (A) | Aperture (mm) | |
|---|---------------------|--------------------|-----|-----|------|------|------|------------------------|---------------|-------------|
| | | 150 | 400 | 600 | 1600 | 2000 | 4000 | | | 6000 |
|  | TF-600 | | | | | | | | Ø 600 | 32 ... 7200 |
| | TF-300 | | | | | | | | Ø 300 | 32 ... 7200 |
| | TF-200 | | | | | | | | Ø 200 | 12 ... 4800 |
| | TF-120 | | | | | | | | Ø 120 | 8 ... 2400 |
| | TF-80 | | | | | | | | Ø 80 | 3 ... 720 |



- Maintenance
Our technicians support you with the monitoring of the electrical insulation and to locate insulation faults within your distribution. You can also request our intervention when needed.

- Training
We offer several training courses for you to discover the key points on earthing systems, manage the location of faults and easily set up your devices.

6 Portable insulation fault location system

ISOM FP-60

With its insulation measurement mode and its oscilloscope-type display, ISOM FP-60 is the tool for tracking insulation faults at the lowest points of the electrical installation.



In-depth insulation measurement (resistive and capacitive) for a better understanding of faults.



Display of the location signal for an accurate analysis of insulation faults.

| FP-60 | JP-61 | PS-61 |
|-----------------------------------|------------------------------------|---|
| Portable insulation fault locator | Portable location current injector | Case includes: - ISOM FP-60 fault locator - ISOM JP-61 injector - 2 clamps, 20 and 52 mm - Network connection accessories (grip wire pliers + cables) |

Standalone insulation monitoring devices

ISOM K-20 & K-40

- Backlit graphic display.
- Versatile mounting options (modular or panel mount).



| | K-20 | K-40 | K-40h |
|--------------------------------------|---------------------------------------|---------------------------------------|--------------------|
| Application | Control circuits | Power distribution | Medical facilities |
| Network | Single-phase, three-phase, continuous | Single-phase, three-phase, continuous | Single-phase |
| Maximum permissible leakage capacity | 30 μF | 150 μF | 5 μF |
| Temperature monitoring | - | • | • |
| Log of average measurements Rf, Ce | - | • | • |
| Communication MODBUS RTU | - | • | • |
| Format/Number of modules | 96 mm/5.5 | 96 mm/5.5 | 96 mm/5.5 |

WEBVIEW-M energy server software solution integrated into the ISOM Digiware system

The ISOM Digiware D-75 remote screens centralise data from all modules in the DIRIS Digiware and ISOM Digiware ranges. Using the WEBVIEW-M software, they allow you to view and remotely evaluate all the real-time and historical measurement data.



Embedded EMS

No installation required: the WEBVIEW analysis and monitoring software is integrated into DIRIS Digiware D-75 and DATALOG H devices.



Global monitoring

Monitors both the insulation level and all the parameters of the electrical installation.



Photoview functionality

Full mapping of the installation (OhmScanner technology) with real-time visualisation of alarms and insulation levels.



Insulation analysis

- Insulation curves.
- Insulation fault alarms.
- Fault location.

Monitoring and alerts

- Real-time electrical readings.
- Alarm tracking dashboard.
- Power quality analysis of circuits.

Visualisation and mapping

- Graphic display of the installation.
- Dashboard of electrical parameters including insulation levels of all circuits.
- Monitoring of all the data collected from the installation.

Example of *ISOM Digiware* system architecture

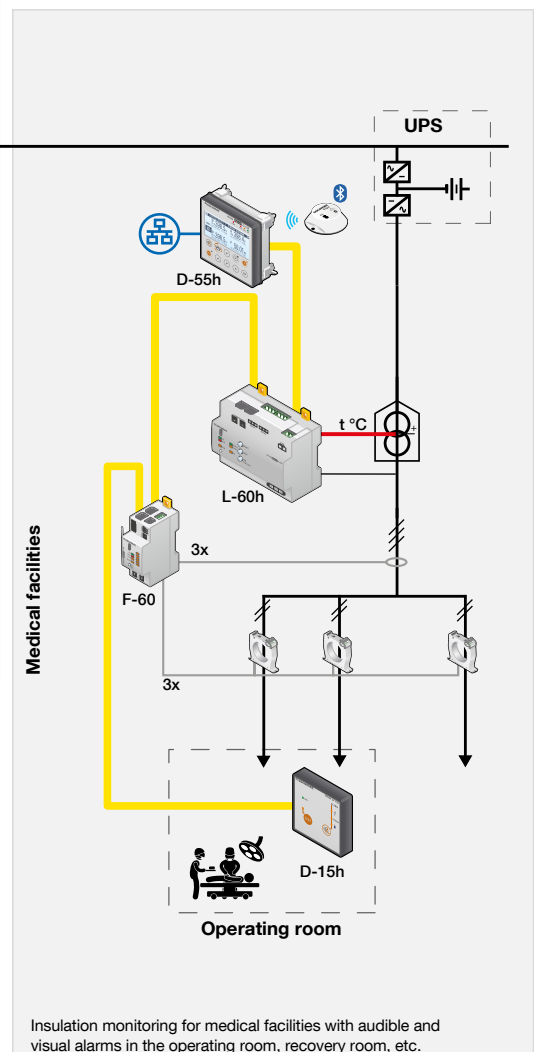
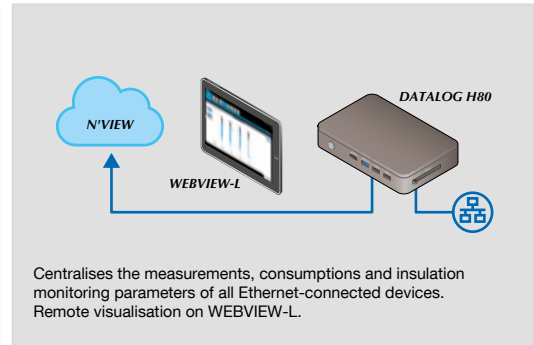
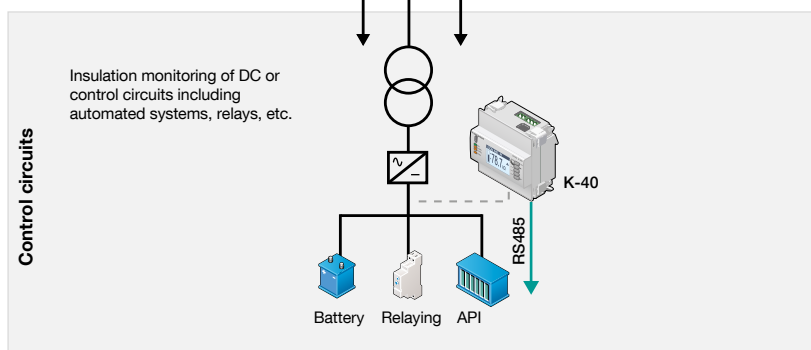
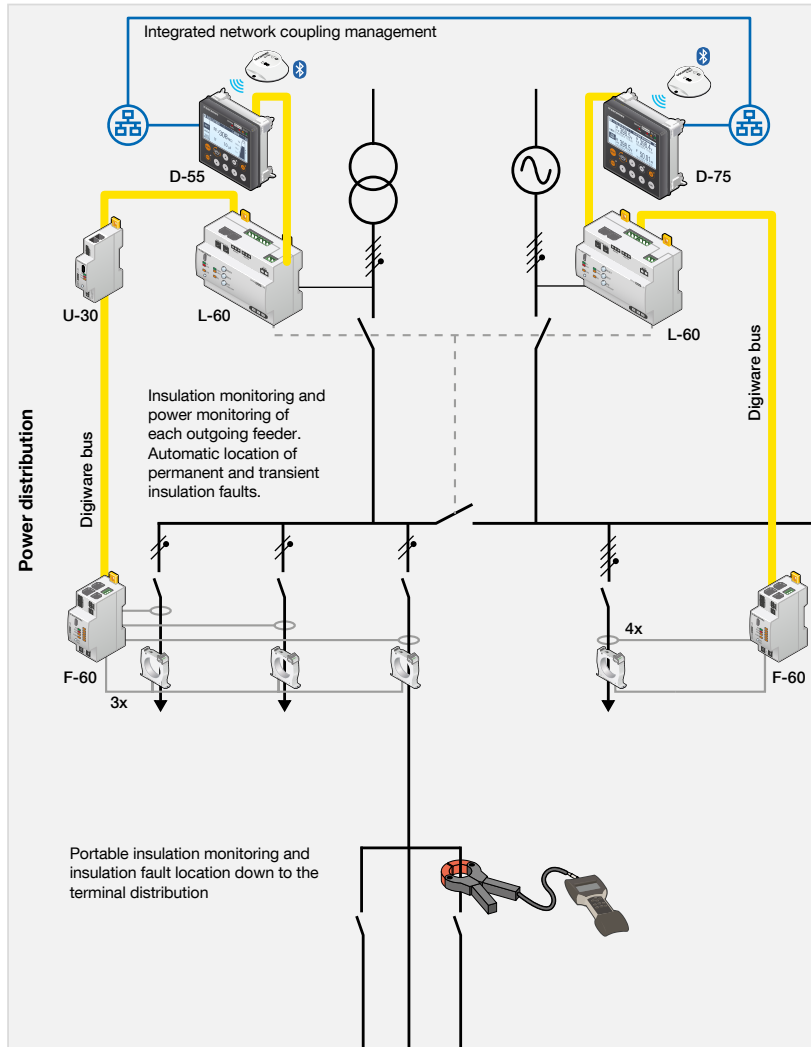

Socomec: our innovations supporting your energy performance

1 independent manufacturer

3,600 employees
worldwide

10 % of sales revenue
dedicated to R&D

400 experts
dedicated to service provision

Your power management expert



POWER
SWITCHING



POWER
MONITORING



POWER
CONVERSION



ENERGY
STORAGE



EXPERT
SERVICES

The specialist for critical applications

- Control, command of LV facilities
- Safety of persons and assets
- Measurement of electrical parameters
- Energy management
- Energy quality
- Energy availability
- Energy storage
- Prevention and repairs
- Measurement and analysis
- Optimisation
- Consultancy, commissioning and training

A worldwide presence

12 production sites

- France (x3)
- Italy (x2)
- Tunisia
- India
- China (x2)
- USA (x3)

28 subsidiaries and commercial locations

- Algeria • Australia • Belgium • China • Canada
- Dubai (United Arab Emirates) • France • Germany
- India • Indonesia • Italy • Ivory Coast • Netherlands
- Poland • Portugal • Romania • Serbia • Singapore
- Slovenia • South Africa • Spain • Switzerland
- Thailand • Tunisia • Turkey • UK • USA

80 countries

where our brand is distributed

HEAD OFFICE

SOCOMECC GROUP

SAS SOCOMECC capital 10 646 360 €
R.C.S. Strasbourg B 548 500 149
B.P. 60010 - 1, rue de Westhouse
F-67235 Benfeld Cedex
Tel. +33 3 88 57 41 41 - Fax +33 3 88 57 78 78
info.scp.isd@socomec.com

YOUR DISTRIBUTOR / PARTNER

www.socomec.com



100 years
OF SHARED ENERGY
1922 — 2022

socomec
Innovative Power Solutions